

**ZEN**

# **Programmable Relay**

# **OPERATION MANUAL**

**OMRON**



# ZEN Programmable Relay

## Operation Manual

*Revised December 2008*

*This operation manual is for version-2 (-V2) ZEN Programmable Relays only. For version-1 or pre-version-1 ZEN Programmable Relays, refer to operation manual with Cat. No. Z183.*

# ***Preface***

OMRON products are manufactured for use according to proper procedures by a qualified operator and only for the purposes described in this manual.

The ZEN is a compact and highly functional controller that can be used to easily automate small-scale applications. Its development has drawn on OMRON's advanced control technology and expertise in manufacturing various types of controllers.

Version 2 of the ZEN includes Economy-type CPU Units and Communications-type CPU Units. Twin timer operation and operation between days for weekly timers have been added. Pulse output operation and 8-digit counters with high-speed counting have also been added, and Expansion I/O Units have been downsized to half the width.

This manual describes how to use version 2 of the ZEN. Before using the ZEN, read this manual carefully so that you can use the ZEN correctly. Keep the manual close at hand so that you can refer to it whenever necessary.

## **Intended Audience**

This manual is intended for the following readers.

- Persons in charge of introducing FA devices
- Persons who design FA systems
- Persons who install or connect FA devices
- Persons who manage working FA installations

Persons who use this product must have sufficient knowledge of electrical systems (i.e., an electrical engineer or the equivalent).

# ***Warranty and Application Considerations***

## **Read and Understand this Manual**

Please read and understand this manual before using the product. Please consult your OMRON representative if you have any questions or comments.

## **Warranty and Limitations of Liability**

### **Warranty and Limitations of Liability**

#### **WARRANTY**

OMRON's exclusive warranty is that the products are free from defects in materials and workmanship for a period of one year (or other period if specified) from date of sale by OMRON.

OMRON MAKES NO WARRANTY OR REPRESENTATION, EXPRESS OR IMPLIED, REGARDING NON-INFRINGEMENT, MERCHANTABILITY, OR FITNESS FOR PARTICULAR PURPOSE OF THE PRODUCTS. ANY BUYER OR USER ACKNOWLEDGES THAT THE BUYER OR USER ALONE HAS DETERMINED THAT THE PRODUCTS WILL SUITABLY MEET THE REQUIREMENTS OF THEIR INTENDED USE. OMRON DISCLAIMS ALL OTHER WARRANTIES, EXPRESS OR IMPLIED.

#### **LIMITATIONS OF LIABILITY**

OMRON SHALL NOT BE RESPONSIBLE FOR SPECIAL, INDIRECT, OR CONSEQUENTIAL DAMAGES, LOSS OF PROFITS OR COMMERCIAL LOSS IN ANY WAY CONNECTED WITH THE PRODUCTS, WHETHER SUCH CLAIM IS BASED ON CONTRACT, WARRANTY, NEGLIGENCE, OR STRICT LIABILITY.

In no event shall the responsibility of OMRON for any act exceed the individual price of the product on which liability is asserted.

IN NO EVENT SHALL OMRON BE RESPONSIBLE FOR WARRANTY, REPAIR, OR OTHER CLAIMS REGARDING THE PRODUCTS UNLESS OMRON'S ANALYSIS CONFIRMS THAT THE PRODUCTS WERE PROPERLY HANDLED, STORED, INSTALLED, AND MAINTAINED AND NOT SUBJECT TO CONTAMINATION, ABUSE, MISUSE, OR INAPPROPRIATE MODIFICATION OR REPAIR.

## Application Consideration

### **SUITABILITY FOR USE**

THE PRODUCTS CONTAINED IN THIS DOCUMENT ARE NOT SAFETY RATED. THEY ARE NOT DESIGNED OR RATED FOR ENSURING SAFETY OF PERSONS, AND SHOULD NOT BE RELIED UPON AS A SAFETY COMPONENT OR PROTECTIVE DEVICE FOR SUCH PURPOSES. Please refer to separate catalogs for OMRON's safety rated products.

OMRON shall not be responsible for conformity with any standards, codes, or regulations that apply to the combination of products in the customer's application or use of the product.

At the customer's request, OMRON will provide applicable third party certification documents identifying ratings and limitations of use that apply to the products. This information by itself is not sufficient for a complete determination of the suitability of the products in combination with the end product, machine, system, or other application or use.

The following are some examples of applications for which particular attention must be given. This is not intended to be an exhaustive list of all possible uses of the products, nor is it intended to imply that the uses listed may be suitable for the products:

- Outdoor use, uses involving potential chemical contamination or electrical interference, or conditions or uses not described in this document.
- Nuclear energy control systems, combustion systems, railroad systems, aviation systems, medical equipment, amusement machines, vehicles, safety equipment, and installations subject to separate industry or government regulations.
- Systems, machines, and equipment that could present a risk to life or property.

Please know and observe all prohibitions of use applicable to the products.

NEVER USE THE PRODUCTS FOR AN APPLICATION INVOLVING SERIOUS RISK TO LIFE OR PROPERTY WITHOUT ENSURING THAT THE SYSTEM AS A WHOLE HAS BEEN DESIGNED TO ADDRESS THE RISKS, AND THAT THE OMRON PRODUCT IS PROPERLY RATED AND INSTALLED FOR THE INTENDED USE WITHIN THE OVERALL EQUIPMENT OR SYSTEM.

## Disclaimers

### Disclaimers

#### **CHANGE IN SPECIFICATIONS**

Product specifications and accessories may be changed at any time based on improvements and other reasons.

It is our practice to change model numbers when published ratings or features are changed, or when significant construction changes are made. However, some specifications of the products may be changed without any notice. When in doubt, special model numbers may be assigned to fix or establish key specifications for your application on your request. Please consult with your OMRON representative at any time to confirm actual specifications of purchased products.

#### **DIMENSIONS AND WEIGHTS**

Dimensions and weights are nominal and are not to be used for manufacturing purposes, even when tolerances are shown.

#### **PERFORMANCE DATA**

Performance data given in this manual is provided as a guide for the user in determining suitability and does not constitute a warranty. It may represent the result of OMRON's test conditions, and the users must correlate it to actual application requirements. Actual performance is subject to the OMRON Warranty and Limitations of Liability.

#### **ERRORS AND OMISSIONS**

The information in this document has been carefully checked and is believed to be accurate; however, no responsibility is assumed for clerical, typographical, or proofreading errors, or omissions.

## Copyright and Copy Permission

### Copyright and Copy Permission

#### **COPYRIGHT AND COPY PERMISSION**

This document shall not be copied for sales or promotions without permission.

This document is protected by copyright and is intended solely for use in conjunction with the product. Please notify us before copying or reproducing this document in any manner, for any other purpose. If copying or transmitting this document to another, please copy or transmit it in its entirety.

# ***OMRON Product References***

All OMRON products are capitalized in this manual. The word “Unit” is also capitalized when it refers to an OMRON product, regardless of whether or not it appears in the proper name of the product.

## ***Visual Aids***

The following headings appear in the left column of the manual to help you locate different types of information.

**Note** Indicates information of particular interest for efficient and convenient operation of the product.

**1,2,3...** 1. Indicates lists of one sort or another, such as procedures, checklists, etc.

**|| Precautions for Correct Use ||**

**|| Precautions for Safe Use ||**

Indicates precautionary information that should be heeded in using the ZEN.



# About this Manual

This operation manual is for version-2 (-V2) ZEN Programmable Relays only. For version-1 or pre-version-1 ZEN Programmable Relays, refer to operation manual with Cat. No. Z183.

When using a CPU Unit with an LED display (without LCD display), refer to the *ZEN Support Software Operation Manual* (Cat. No. Z184).

## Manual Contents

**Section 1** gives an outline of the ZEN, including descriptions of ZEN features and functions.

**Section 2** explains how to mount and wire the ZEN and how to connect sensors.

**Section 3** explains basic settings required to operate the ZEN and setting methods for internal bits.

**Section 4** describes the many convenient functions provided by the ZEN.

**Section 5** describes how to use optional products, such as Battery Units and Memory Cassettes.

**Section 6** lists the error messages and provides probable causes and countermeasures for troubleshooting.

The **Appendices** provide specifications, technical references, version update information, allocations and setting sheets, and other information related to ZEN operation.

## Related Manual

Manual	Contents	Cat. No.
ZEN Support Software Operation Manual	Describes installation and operating procedures for the ZEN Support Software.	Z184
Communications Manual	Describes the communications functions of the ZEN.	Z212

# Visual Aids

The following headings appear in the left column of the manual to help you locate different types of information.

**Note** Indicates information of particular interest for efficient and convenient operation of the product.

**1,2,3...** 1. Indicates lists of one sort or another, such as procedures, checklists, etc.

## || Precautions for Correct Use ||

Indicates precautionary information that should be heeded to ensure correct use of the ZEN.

## || Precautions for Safe Use ||

Indicates precautionary information that should be heeded to ensure safe use of the ZEN.



Indicates that the display (the word “LANGUAGE” in this case) is flashing. In this manual, this state is described by saying that the “flashing cursor” is at the word “LANGUAGE”. In this state it is possible to change settings and the position of the cursor.

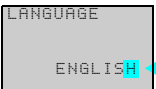

Indicates that the display (the letter “H” in this case) is flashing in reverse video. In this manual, this state is described by saying that the “highlighted cursor” is at the word “H”. In this state it is not possible to change settings but the cursor can be changed to the flashing cursor by pressing the OK button.



Indicate the buttons that needs to be pressed in operating procedures. Press each button once.



Indicate buttons that needs to be pressed in operating procedures. Press one of the buttons once or more.

## © OMRON, 2006

All rights reserved. No part of this publication may be reproduced, stored in a retrieval system, or transmitted, in any form, or by any means, mechanical, electronic, photocopying, recording, or otherwise, without the prior written permission of OMRON.

No patent liability is assumed with respect to the use of the information contained herein. Moreover, because OMRON is constantly striving to improve its high-quality products, the information contained in this manual is subject to change without notice. Every precaution has been taken in the preparation of this manual. Nevertheless, OMRON assumes no responsibility for errors or omissions. Neither is any liability assumed for damages resulting from the use of the information contained in this publication.

# TABLE OF CONTENTS

Preface . . . . .	iv
Warranty and Application Considerations . . . . .	v
OMRON Product References . . . . .	viii
Visual Aids . . . . .	viii
About this Manual . . . . .	ix
Visual Aids . . . . .	x
<b>Precautions . . . . .</b>	<b>xiii</b>
Safety Precautions . . . . .	xiv
Precautions for Safe Use . . . . .	xvi
Precautions for Correct Use . . . . .	xix
Conformance to EC Directives . . . . .	xxi
<b>SECTION 1</b>	
<b>Outline . . . . .</b>	<b>1</b>
1-1 Outline . . . . .	2
1-2 Features and Models . . . . .	8
1-3 Nomenclature and Basic Operation . . . . .	15
1-4 Memory Areas . . . . .	29
1-5 Allocating I/O Bit Numbers . . . . .	32
1-6 Preparations for Operation . . . . .	33
<b>SECTION 2</b>	
<b>Installation and Wiring . . . . .</b>	<b>35</b>
2-1 Mounting . . . . .	36
2-2 Wiring . . . . .	38
<b>SECTION 3</b>	
<b>Programming and Operating Methods . . . . .</b>	<b>55</b>
3-1 Selecting Display Language . . . . .	57
3-2 Setting the Date and Time . . . . .	58
3-3 Creating Ladder Programs . . . . .	60
3-4 Confirming Ladder Program Operation . . . . .	69
3-5 Correcting Ladder Programs . . . . .	71
3-6 Using Timers (T) and Holding Timers (#) . . . . .	74
3-7 Using Counters (C) and the 8-Digit Counter (F) . . . . .	78
3-8 Using Weekly Timers (@) . . . . .	81
3-9 Using Calendar Timers (*) . . . . .	86
3-10 Analog Inputs (Analog Comparators (A)) . . . . .	87
3-11 Comparing Timer/Counter Present Values Using Comparators (P) . . . . .	91

# TABLE OF CONTENTS

3-12	Comparing the 8-Digit Counter (F) Present Value Using 8-Digit Comparators (G) . . . . .	94
3-13	Displaying Messages (Display Bits (D)) . . . . .	96
3-14	Using Button Input Bits (B) . . . . .	99

## SECTION 4

<b>Special Functions</b> . . . . .	<b>101</b>	
4-1	Protecting Programs . . . . .	102
4-2	Stabilizing Input Operations . . . . .	104
4-3	Changing Backlight Automatic Cutout Time . . . . .	106
4-4	Setting Daylight Saving Time (DST) . . . . .	107
4-5	Reading System Information . . . . .	108

## SECTION 5

<b>Optional Products</b> . . . . .	<b>109</b>	
5-1	Mounting Battery Units . . . . .	110
5-2	Using Memory Cassettes . . . . .	111
5-3	Connecting the ZEN Support Software . . . . .	114

## SECTION 6

<b>Troubleshooting</b> . . . . .	<b>115</b>	
6-1	Troubleshooting . . . . .	116
6-2	Error Messages . . . . .	116
6-3	Deleting Error Messages . . . . .	118

## Appendices

A	Specifications . . . . .	119
B	Ladder Program Execution . . . . .	129
C	Operating Mode at Startup . . . . .	133
D	Version Upgrades . . . . .	135
E	Application Examples . . . . .	143
F	Allocations and Setting Table . . . . .	157

<b>Index</b> . . . . .	<b>165</b>
------------------------	------------

<b>Revision History</b> . . . . .	<b>169</b>
-----------------------------------	------------

# Precautions

This section provides precautions for using the ZEN Programmable Relays.

This information contained in this section is important for the safe and reliable application of the ZEN. You must read this section and understand the information before attempting to set up for a ZEN.

Safety Precautions . . . . .	xiv
Precautions for Safe Use . . . . .	xvi
Precautions for Correct Use . . . . .	xix
Conformance to EC Directives . . . . .	xxi

**Safety Precautions**

**Definition of Precautionary Information**

The following notation is used in this manual to provide precautions required to ensure safe usage of the product.





The safety precautions that are provided are extremely important to safety. Always read and heed the information provided in all safety precautions.

The following notation is used.

 <b>WARNING</b>	<p>Indicates a potentially hazardous situation which, if not avoided, will result in minor or moderate injury, or may result in serious injury or death. Additionally, there may be significant property damage.</p>
--	--

 <b>CAUTION</b>	<p>Indicates a potentially hazardous situation which, if not avoided, may result in minor or moderate injury or in property damage.</p>
--	---

**Symbols**

<b>Symbol</b>		<b>Meaning</b>
Caution		<p><b>General Caution</b> Indicates non-specific general cautions, warnings, and dangers.</p>
		<p><b>Electrical Shock Caution</b> Indicates possibility of electric shock under specific conditions.</p>
		<p><b>Explosion Caution</b> Indicates possibility of explosion under specific conditions.</p>
Prohibition		<p><b>Disassembly Prohibition</b> Indicates prohibitions when there is a possibility of injury, such as from electric shock, as the result of disassembly.</p>
Mandatory Caution		<p><b>General Caution</b> Indicates non-specific general cautions, warnings, and dangers.</p>

**Precautions****⚠ WARNING**

Serious human hazard may occasionally occur due to ignition or rupture of the lithium battery used in the Battery Unit. Do not short the battery terminals or charge, disassemble, deform under pressure, or incinerate the battery.

Never use any battery that has been dropped on the floor or otherwise subjected to excessive shock.

**⚠ CAUTION**

Electric shock, fire, or malfunction may occur. Do not disassemble, modify, or repair the ZEN or touch any of the internal parts.



Electrical shock may occur. Never touch the I/O terminals, computer connector, Expansion Unit connector, or Battery Unit connector while power is being supplied.



Electrical shock may occur. Do not remove the Expansion Unit connector cover unless an Expansion I/O Unit will be permanently installed.



Fires may occasionally occur. Tighten the terminal screws to a torque of 0.565 to 0.6 N·m (5 to 5.3 in·lb).

<b>Precautions for Safe Use</b>
---------------------------------

Please observe the following precautions for safe use of this products.

**Circuit Design**

1. All interface connectors and battery connector are live parts, they may not be directly connected to Softy Extra Low Voltage (SELV) circuit or to accessible conductive parts.  
For the programming units and Personal Computers use only the ZEN-CIF01 Connecting Cable (optional accessory) manufactured by OMRON.  
ZEN-CIF01 provides safe (reinforced) insulation between Personal Computers and ZEN.
2. Provide emergency stop circuits, external interlock circuits, limit circuits, and other safety circuits in addition to any provided within the ZEN control circuits to ensure safety of the overall system in the event of ZEN failure or external factors.
3. If the ZEN discovers an error during self-diagnosis, operation will be stopped and all outputs will be turned OFF. As a countermeasure for such problems, external safety measures must be provided to ensure safety in the overall system.
4. Outputs from the ZEN may remain ON or OFF due to faults in internal circuits such as output relay fusing or burning, or output transistor destruction. As a countermeasure for such problems, external safety measures must be provided to ensure safety in the overall system.
5. Fail-safe measures must be taken by the user to ensure overall system safety in the event of broken signal lines or momentary power interruptions.
6. The durability of the output relays is largely affected by the switching conditions. Confirm the operation of the system under actual operating conditions and set the switching frequency to ensure that adequate performance will be provided. Insulation faults and burning in the ZEN may result if relays are used after their performance has deteriorated.

**Connecting Expansion I/O Units**

1. Supply power to both the CPU Unit and Expansion I/O Units from the same power supply and turn them ON and OFF at the same time.
2. When connecting Expansion I/O Units with DC inputs to a CPU Unit with an AC power supply, the burst noise immunity will be 1 kV (IEC 61000-4-4).
3. Expansion I/O Units with AC inputs (ZEN-8E1AR) cannot be connected to a CPU Unit with a DC power supply.

**System Startup and Program Changes**

1. Check the user program for proper execution before actually running it on the Unit.
2. Disconnect the output lines from the system before testing operation in any system in which incorrect operation can result in injury or equipment damage.
3. Confirm safety before attempting any of the following operations.
  - Changing the operating mode (RUN/STOP).



- Using the button switches.
  - Changing bit status or parameter settings.
4. Double-check all wiring before turning ON the power supply.
  5. Refer to *Cycle Time Calculation Method on page 130* and confirm that the increase in the cycle time will not affect operation. If the cycle time is too long, it may become impossible to read input signals accurately. The increase in the cycle time will be particularly noticeable when set values are written in RUN mode for a CPU Unit with communications (ZEN-10C4□R-□-V2).

### **Installation and Wiring**

1. Do not allow the ZEN to fall during installation.
2. Be sure that the DIN Track mounting levers, Expansion I/O Units, Memory Cassettes, Battery Units, cable connectors, and other items with locking devices are properly locked into place. Improper locking may result in malfunction.
3. When mounting the ZEN to the surface of the control panel, tighten mounting screws to the following torques.  
CPU Units: 1.03 N·m max.  
Expansion I/O Units: 0.46 N·m max.
4. Use wires with cross-sectional areas of 0.2 to 2.5 mm<sup>2</sup> (equivalent to AWG24 to AWG14) for wiring and strip them for 6.5 mm.

### **Handling**

1. The environment of use of ZEN is "Pollution degree 2" and "Overvoltage category II" specified in IEC60664-1.
2. Always use the ZEN within the rated ambient operating temperature and humidity. The rated ambient operating temperature is 0 to 55°C for LCD-type CPU Units and -25 to 55°C for LED-type CPU Units. If the ZEN is used near sources of heat, such as a power supply, the internal temperature of the ZEN may increase, lowering the durability of the ZEN.
3. Discharge static electricity from your body, e.g., by touching a grounded metal plate, before touching any Unit.
4. The exterior of the Units will be damaged if it comes into contact with organic solvents (e.g., benzene or paint thinner), strong alkalis, or strong acids. Never allow such substances to come into contact with the Units.
5. Do not apply voltages exceeding the rated voltages. Internal elements may be destroyed.
6. Short failures or open failures may result from the destruction of output elements. Do not use loads that exceed the rated output current.

### **Maintenance**

When replacing a CPU Unit, transfer to the new Unit and confirm all settings for clock data, internal holding bits, holding timers, and counters before starting operation again.

### **Transportation and Storage**

1. Use special packaging boxes when transporting the ZEN and do not subject it to excessive shock or vibration or drop it during shipment.

2. Store the ZEN at an ambient temperature of  $-40$  to  $75^{\circ}\text{C}$  for LED-type CPU Units and  $-20$  to  $75^{\circ}\text{C}$  for all other types of CPU Units. If the ZEN has been stored at  $-10^{\circ}\text{C}$  or lower, allow it to stand at room temperature for 3 hours or longer before turning ON the power supply.

<b>Precautions for Correct Use</b>
------------------------------------

**Installation Environment**

1. Do not install the ZEN in the following locations.
  - Locations subject to radical changes in temperature
  - Location with high humidity subject to condensation
  - Locations subject to excessive dust or dirt
  - Locations subject to corrosive gas
  - Locations subject to direct sunlight
2. Do not install the ZEN in locations subject to shock or vibration. Extended use in such location may cause damage from stress.
3. In environments subject to static electricity (e.g., close to pipes conveying forming materials, powders, or fluid materials), separate the ZEN as far as possible from the source of static electricity.
4. The ZEN is neither waterproof nor oil-proof. Do not use it in locations subject to water or oil.
5. Use the ZEN within the allowable power supply voltage range. Be particularly careful in locations with bad power supply conditions, e.g., large fluctuations in the power supply voltage.
6. Do not install the ZEN in locations subject to excessive noise, which may cause the ZEN to fail.
7. Take appropriate and sufficient countermeasures when installing systems in the following locations:
  - Locations subject to strong electromagnetic fields
  - Locations subject to possible exposure to radioactivity

**Power Supply**

1. Always turn OFF the power supply to the ZEN (CPU Unit and Expansion I/O Units) before attempting any of the following.
  - Assembling the ZEN
  - Attaching or removing Expansion I/O Units
  - Connecting or disconnecting any cables or wiring
  - Attaching or removing the Memory Cassette
  - Attaching or removing the Battery Unit
2. If the power supply is interrupted for 2 days or more (at 25°C), the internal capacitor will discharge and internal bit status and the contents of PV areas will be lost or corrupted and dates and times will be reset. When restarting operation after the power supply has been interrupted for an extended period of time, check the system in advance to confirm that no errors will occur.

**Handling**

1. Connect connectors only after confirming that the direction or polarity is correct.
2. Failures could result if dust or dirt enters the ZEN. Always connect the connector cover to the computer connector whenever it is not being used.

3. Do not remove the label from the left side of the CPU Unit if a Battery Unit is not mounted.

### Other

1. The execution of the ladder program in the ZEN is different from that for other PLCs. Refer to *Appendix B Ladder Program Execution* when writing the ladder program.
2. Abide by all local ordinances and regulations when disposing of the ZEN.
3. The Battery Unit (ZEN-BAT01, sold separately) contains a lithium battery. Observe all applicable legal requirements for your area when disposing of the lithium battery.



廢電池請回收

# Conformance to EC Directives

## Applicable Directives

- EMC Directives
- Low Voltage Directive

## Concepts

### EMC Directives

OMRON devices that comply with EC Directives also conform to the related EMC standards so that they can be more easily built into other devices or the overall machine. The actual products have been checked for conformity to EMC standards. The ZEN complies with IEC/EN61131-2 clause 8. Whether the products conform to the standards in the system used by the customer, however, must be checked by the customer.

EMC-related performance of the OMRON devices that comply with EC Directives will vary depending on the configuration, wiring, and other conditions of the equipment or control panel on which the OMRON devices are installed. The customer must, therefore, perform the final check to confirm that devices and the overall machine conform to EMC standards.

### Low Voltage Directive

Always ensure that devices operating at voltages of 50 to 1,000 VAC and 75 to 1,500 VDC meet the required safety standards. The ZEN complies with IEC/EN61131-2 clause 11 except for 11.7.2.2.

## Conformance to EC Directives

The ZEN complies with EC Directives. To ensure that the machine or device in which the ZEN is used complies with EC Directives, the ZEN must be installed as follows:

1. The ZEN is an open-structure device. To meet the requirements of IEC/EN 61131-2 for open-structure devices, the ZEN must be mounted inside a control panel and protected from mechanical impact as described on page 36.
2. Do not exceed a cable length of 10 m when connecting transistor outputs.
3. Burst immunity will no longer meet IEC/EN 61131-2 requirements if an Expansion I/O Unit with DC inputs is connected to a CPU Unit with an AC power supply.
4. ZEN models complying with EC Directives also conform to the Common Emission Standard (IEC/EN61131-2 clause 8). Radiated emission characteristics (10-m regulations) may vary depending on the configuration of the control panel used, other devices connected to the control panel, wiring, and other conditions. You must therefore confirm that the overall machine or equipment complies with EC Directives.

## Relay Output Noise Reduction Methods

The ZEN conforms to EN 61131-2 of the EMC Directives. However, noise generated by relay output switching may not satisfy these Standards. In such a case, a noise filter must be connected to the load side or other appropriate countermeasures must be provided external to the ZEN.

Countermeasures taken to satisfy the standards vary depending on the devices on the load side, wiring, configuration of machines, etc. Following are examples of countermeasures for reducing the generated noise.

### Countermeasures

(Refer to EN61131-2 for more details.)

- Countermeasures are not required if the frequency of load switching for the whole system with the ZEN included is less than 5 times per minute.
- Countermeasures are required if the frequency of load switching for the whole system with the ZEN included is 5 times per minute or higher.

### Countermeasure Examples

When switching an inductive load, connect a surge protector, diodes, etc., in parallel with the load or contact as shown below.

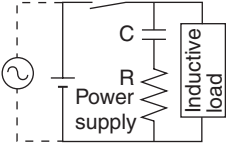
Circuit	Current		Characteristic	Required element
	AC	DC		
<p>CR method</p> 	Yes	Yes	<p>If the load is a relay or solenoid, there is a time lag between the moment the circuit is opened and the moment the load is reset.</p> <p>If the supply voltage is 12 to 48 V, insert the surge protector in parallel with the load. If the supply voltage is 100 to 200 V, insert the surge protector between the contacts.</p>	<p>The capacitance of the capacitor must be 1 to 0.5 <math>\mu\text{F}</math> per contact current of 1 A and resistance of the resistor must be 0.5 to 1 <math>\Omega</math> per contact voltage of 1 V. These values, however, vary with the load and the characteristics of the relay. Decide these values from experiments, and take into consideration that the capacitance suppresses spark discharge when the contacts are separated and the resistance limits the current that flows into the load when the circuit is closed again.</p> <p>The dielectric strength of the capacitor must be 200 to 300 V. If the circuit is an AC circuit, use a capacitor with no polarity.</p>

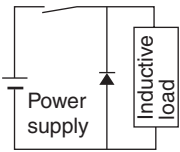
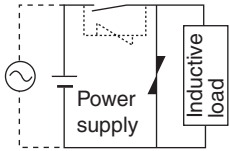
Circuit	Current		Characteristic	Required element
	AC	DC		
<p>Diode method</p> 	No	Yes	<p>The diode connected in parallel with the load changes energy accumulated by the coil into a current, which then flows into the coil so that the current will be converted into Joule heat by the resistance of the inductive load.</p> <p>This time lag, between the moment the circuit is opened and the moment the load is reset, caused by this method is longer than that caused by the CR method.</p>	<p>The reversed dielectric strength value of the diode must be at least 10 times as large as the circuit voltage value. The forward current of the diode must be the same as or larger than the load current.</p> <p>The reversed dielectric strength value of the diode may be two to three times larger than the supply voltage if the surge protector is applied to electronic circuits with low circuit voltages.</p>
<p>Varistor method</p> 	Yes	Yes	<p>The varistor method prevents the imposition of high voltage between the contacts by using the constant voltage characteristic of the varistor. There is time lag between the moment the circuit is opened and the moment the load is reset.</p> <p>If the supply voltage is 12 to 48 V, insert the varistor in parallel with the load. If the supply voltage is 100 to 200 V, insert the varistor between the contacts.</p>	---





# SECTION 1

## Outline

This section gives an outline of the ZEN, including example applications, the system configurations and basic operations.

1-1	Outline . . . . .	2
1-2	Features and Models . . . . .	8
1-2-1	Features and System Configuration . . . . .	8
1-2-2	List of Models . . . . .	10
1-3	Nomenclature and Basic Operation . . . . .	15
1-3-1	Nomenclature . . . . .	15
1-3-2	Screen Transitions . . . . .	20
1-3-3	Basic Operation . . . . .	24
1-4	Memory Areas . . . . .	29
1-5	Allocating I/O Bit Numbers . . . . .	32
1-6	Preparations for Operation . . . . .	33

# 1-1 Outline

## Economical, Small-scale Automatic Control

One CPU Unit provides 12 inputs and 8 outputs (with CPU Unit with 20 I/O points).

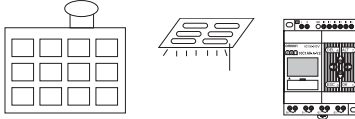

Water-supply facilities in apartments,  
lighting control in offices.

## Easy Operation with an Inexpensive Controller

Ladder programming is possible directly from CPU Unit. When using LED-type CPU Units (without LCD display) with Memory Cassettes (optional), ladder programs can be easily copied.

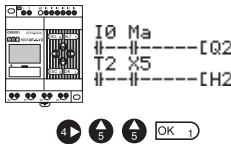

## Smaller Control Panels

The ZEN is very small at 90 x 70 x 56 mm (H x W x D) and mounts essentially anywhere.

**Note** Dimensions are 90 x 122.5 x 56 mm (H x W x D) for CPU Units with 20 I/O points.

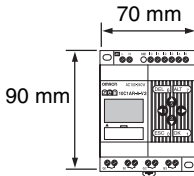

## Less Assembly and Wiring Time Required for Control Panels

Simple one-touch DIN Track mounting. Built-in timers and counters so only power supply and I/O circuit wiring required.

Solid wires can be easily connected using only a screwdriver.

Refer to page 38.

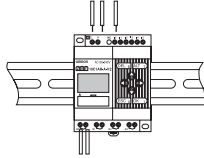

### **Future System Expandability**

I/O capacity can be expanded to up to 24 inputs and 20 outputs by connecting 3 Expansion I/O Units.

Refer to page 9 and 37.

CPU Unit                      Expansion I/O Units (up to 3)

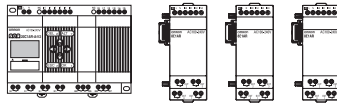

12 inputs/8 outputs + (4 inputs/4 outputs) × 3

### **Power Failure Countermeasures**

EEPROM backs up the program and system settings data when power is supplied to the ZEN.

Use a Battery Unit (optional) to back up work bits, holding timers, counters, and date/time data.

Refer to page 110.

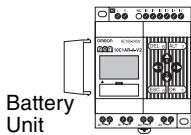

### **Easy Saving and Copying of Programs**

Use an optional Memory Cassette to easily save and copy programs.

Refer to page 111.

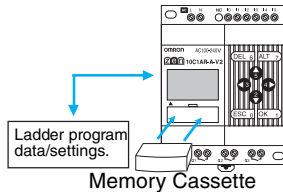

### **Programming and Monitoring from a Personal Computer**

Windows-based ZEN Support Software is available and provides a complete simulation function.

Refer to page 114.

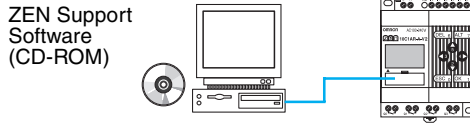

### **Greater Switching Capacity**

The output contacts have 8-A switching capacity (250 VAC). All contacts are independent (for CPU Units with 10 I/O points).

Refer to page 51.

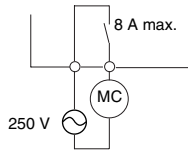

### **AC Inputs**

For CPU Units with AC power supply inputs, 100 to 240 VAC can be directly connected.

Refer to page 41.

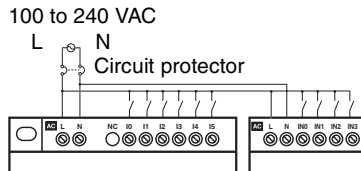

### **Easy Program Design**

There are 3 different operations that can be set for bit outputs. Self-holding bits also can be easily programmed.

Refer to page 65.

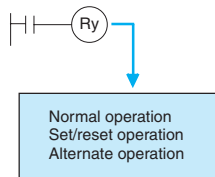

### **Complicated Timers without Additional Programming**

Any of the 16 timers support 5 types of operation and 3 timing ranges.

There are also 8 built-in holding timers that hold data during power interruptions.

Refer to page 74.

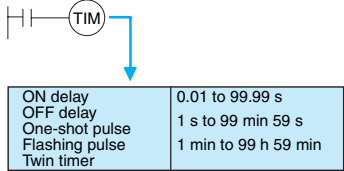

### **Incremental and Decremental Counters**

There are 16 built-in counters that can be switched between incrementing and decrementing.

Use Comparators to enable programming multiple outputs from a counter.

Counters: Refer to page 78.

Comparators: Refer to page 91.

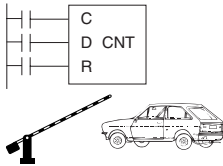

Control number of cars entering and leaving a car park.

### **Season- or Day-dependent Operating Times**

CPU Units with built-in calendar and clock functions have 16 weekly timers and 16 calendar timers. Seasonal control is possible using calendar timers and day/time control is possible with weekly timers.

Weekly timers: Refer to page 81.

Calendar timers: Refer to page 86.

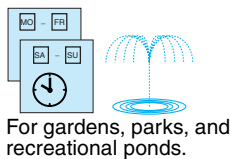

For gardens, parks, and recreational ponds.

### Direct Analog Inputs

CPU Units with DC power supply inputs have 2 analog input points (0 to 10 V) and 4 analog comparators.

Refer to page 87.

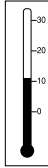
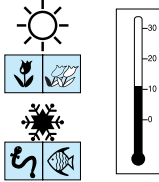

Temperature control for hot houses and tanks. Prevent freezing of swimming pools.

### Easier Maintenance

Use the display function in CPU Units to display user-specified messages, the date, time, or other data. Button switches can also be used as input contacts. Applications include usage as a simple display operation panel.

Refer to page 96.

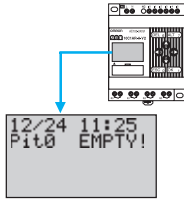

### Longer Backlight for Dark Situations

The automatic cutout time for the backlight for CPU Units can be set to 2, 10, or 30 minutes, or set to operate continuously. With the display function, the backlight can also be set to turn ON when a message is displayed.

Refer to page 106.

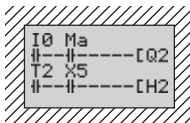

### **Prevent Chattering and Noise-related Malfunctions**

Set the input filters to extend the filter timer and prevent malfunctions.  
Refer to page 104.

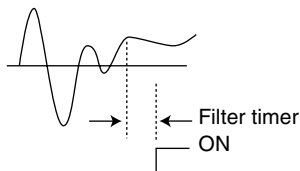

### **Exporting Systems Overseas**

Display for CPU Units is available in 6 languages. A Daylight Saving Time (DST) function also supported.

Changing display language: Refer to page 57.

Daylight Saving Time (DST) settings: Refer to page 107.

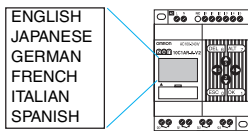

### **Programming Security**

Programs can be protected by setting a password.

Refer to page 102.

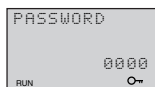

③ ⑨ ⑤ ④ OK →

## 1-2 Features and Models

### 1-2-1 Features and System Configuration

The ZEN is small but has a wide range of functions and is easy to use. The ZEN facilitates small-scale automatic control.

#### **Standard LCD-type, Economy-type, and Communications-type CPU Units**

- Simple button-operated programming.
- Highly visible, backlit LCD.
- Adjustable automatic cutout time for the backlight.
- Six-language display.
- Display function for user-specified messages (4 lines x 12 characters), time, or timer, counter, or analog-converted value displays.
- Button switches allowing operation buttons to be used as input contacts.
- Built-in weekly and calendar timers to allow simple seasonal, daily, or time-based operation.
- Remote monitoring via RS-485 communications (Communications-type CPU Units).

#### **Common Features**

- Both 100 to 240-VAC and 12 to 24-VDC power supply models available.
- Built-in analog comparator for temperature control and other analog applications (provided on CPU Units with DC power supply inputs, two analog inputs 0 to 10 V).
- Input filter settings to prevent noise-related malfunctions for both CPU Units and Expansion I/O Units.
- Program and settings data backed up on built-in EEPROM.
- Programming using ladder diagrams.
- Password function to protect programs.
- Connect up to 3 Expansion I/O Units for a maximum of 24 inputs and 20 outputs.



Work bits, holding timer data, counter data, and date/time data will be backed up during long-term power supply interruptions if a Battery Unit (optional) is mounted.

ZEN-BAT01 Battery Unit

ZEN-ME01 Memory Cassette

Programs can be saved and copied by using a Memory Cassette (optional).

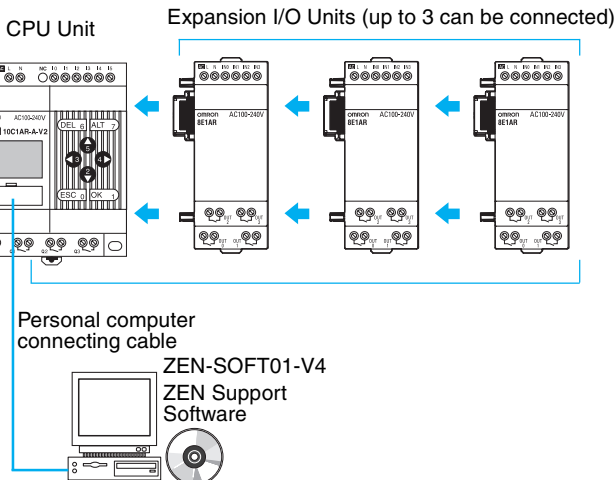

Programs can be created, edited, saved, and printed, and operation can be simulated using the ZEN Support Software (optional).

## 1-2-2 List of Models

### CPU Units with 10 I/O Points

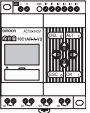
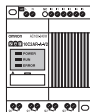
Shape		Power supply/ input voltage	Inputs	Outputs		Analog inputs	Model number
With display and operation buttons 	Standard LCD type	100 to 240 VAC, 50/60 Hz	6 inputs	Relays	4 outputs	No	ZEN-10C1AR-A-V2
		12 to 24 VDC				Yes	ZEN-10C1DR-D-V2
		12 to 24 VDC		Yes		ZEN-10C1DT-D-V2	
	Economy type (Expansion I/O Units cannot be connected)	100 to 240 VAC, 50/60 Hz		Relays	No	ZEN-10C3AR-A-V2	
		12 to 24 VDC			Yes	ZEN-10C3DR-D-V2	
		Communications type		100 to 240 VAC, 50/60 Hz	3 outputs	No	ZEN-10C4AR-A-V2
12 to 24 VDC	Yes		ZEN-10C4DR-D-V2				
LED type Without display 	100 to 240 VAC, 50/60 Hz		4 outputs	No	ZEN-10C2AR-A-V2		
	12 to 24 VDC			Yes	ZEN-10C2DR-D-V2		
	12 to 24 VDC		Transistors	Yes	ZEN-10C2DT-D-V2		

**Note** Refer to *Input Specifications* on page 123 for input specifications.

**CPU Units with 20 I/O Points**

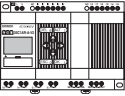
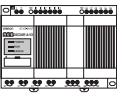
Shape		Power supply	Inputs	Outputs		Analog inputs	Model number
With display and operation buttons 	Standard LCD type	100 to 240 VAC, 50/60 Hz	12 inputs	Relays	8 outputs	No	ZEN-20C1AR-A-V2
		12 to 24 VDC				Yes	ZEN-20C1DR-D-V2
		12 to 24 VDC		Yes		ZEN-20C1DT-D-V2	
	Economy type (Expansion I/O Units cannot be connected)	100 to 240 VAC, 50/60 Hz		Relays		No	ZEN-20C3AR-A-V2
		12 to 24 VDC				Yes	ZEN-20C3DR-D-V2
		LED type		100 to 240 VAC, 50/60 Hz		Transistors	No
Without display 	12 to 24 VDC	Yes	ZEN-20C2DR-D-V2				
	12 to 24 VDC	Yes	ZEN-20C2DT-D-V2				

**Note** Refer to *Input Specifications* on page 123 for input specifications.

**Differences between LCD- and LED-type CPU Units**

Item		LCD-type CPU Units (See note 1.)		LED-type CPU Units (See note 2.)	
		AC power supply	DC power supply	AC power supply	DC power supply
Program editing, parameter settings, operation monitoring		Yes (Also possible with ZEN Support Software.)		ZEN Support Software required.	
Operating mode switching		Yes (Also possible with ZEN Support Software)		ZEN Support Software required.	
Calendar and clock function		Yes		No	
Bits	Input, output, work, holding bits	Yes		Yes	
	Timer, holding timer, counter	Yes		Yes	
	High-speed counting with 8-digit counter	No	Yes	No	Yes
	Weekly timer, calendar timer	Yes		No	
	Analog comparator	No	Yes	No	Yes
	Timer/counter comparator	Yes		Yes	
	Button switches	Yes		No	
	Display function	Yes		No	
Settings	Display language	Yes (Also possible with ZEN Support Software.)		-	
	Backlight cutout time	Yes (Also possible with ZEN Support Software.)		-	
	Input filters	Yes (Also possible with ZEN Support Software.)		ZEN Support Software required.	
	Password	Yes (Also possible with ZEN Support Software.)		ZEN Support Software required.	
Memory Cassette functions	ZEN to Memory Cassette transfer	Yes		No	
	Memory Cassette to ZEN transfer	Yes		Yes (Automatic transfer when power is turned ON.)	
	Memory Cassette initialization	Yes		No	
Battery Unit connection		Yes		Yes	
ZEN Support Software connection		Yes		Yes	

- Note**
1. Standard LCD-type, Economy-type, and Communications-type CPU Units: All models except ZEN-C2□□-□-V2
  2. LED-type CPU Units: ZEN-C2□□-□-V2
  3. Operations using ZEN Support Software are also possible.

### Expansion I/O Units



No. of I/O points	Inputs		Outputs		Connectable CPU Units	Model number
8 I/O 	100 to 240 VAC, 50/60 Hz	4 inputs	Relays	4 outputs	ZEN-□C1AR-A-V2 ZEN-□C2AR-A-V2 ZEN-10C4AR-A-V2	ZEN-8E1AR (See note 1.)
	12 to 24 VDC	4 inputs	Relays	4 outputs	ZEN-□C1□□-□-V2 ZEN-□C2□□-□-V2 ZEN-10C4AR-A-V2	ZEN-8E1DR
	12 to 24 VDC	4 inputs	Transistors	4 outputs		ZEN-8E1DT

- Note**
1. The ZEN-8E1AR cannot be connected to a CPU Unit with DC power supply.
  2. Refer to *Input Specifications on page 123* for input specifications.



### Power Supply Unit

Name and appearance	Specifications	Model number
Switching Power supply Unit 	Input voltage: 100 to 240 VAC Output voltage: 24 VDC Output capacity: 1.3 A Capacity: 30 W	ZEN-PA03024

### Programming Device

Name and appearance	Functions	Model number
ZEN Support Software 	Runs on Windows 98, 98SE, ME, 2000, XP, NT4.0 Service Pack 3, or Vista (CD-ROM) Used for offline programming, all parameter settings, program transfers, and printing.	ZEN-SOFT01-V4
Personal Computer Connecting Cable 	Connects the computer and ZEN when the ZEN Support Software is used. (Cable length: 2 m)	ZEN-CIF01

**Optional Products**

Name and appearance	Functions		Model number
Memory Cassette 	EEP-ROM Used to save and copy programs.		ZEN-ME01
Battery Unit 	Uses a battery to back up programs and data. Mount a Battery Unit if the loss of calendar, clock, holding bit, holding timer, and counter present values will cause problems in systems with long power interruptions. (Battery life: 10 years minimum)		ZEN-BAT01
Training Kit	This kit is recommended for first-time users. Contains the following products and manuals as a kit. CPU Unit ZEN-SOFT01-V4 ZEN Support Software ZEN-CIF01 Personal Computer Connecting Cable ZEN Operation Manual (Z211) ZEN Support Software Operation Manual (Z184)	ZEN-10C1AR-A-V2 CPU Unit (AC power supply)	ZEN-KIT01-EV4
		ZEN-10C1DR-D-V2 CPU Unit (DC power supply)	ZEN-KIT02-EV4

# 1-3 Nomenclature and Basic Operation

## 1-3-1 Nomenclature

### Standard LCD-type, Economy-type, and Communications-type CPU Units

#### Models with 10 I/O Points

Left Side

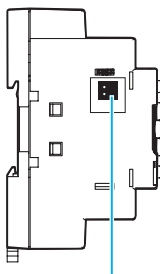

Battery Unit connector  
(Remove the seal to connect the Battery Unit.)

Front  
Power supply terminals    Input terminals

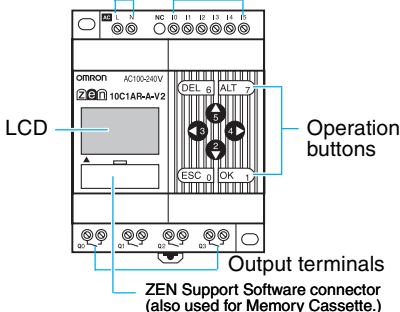

Right Side

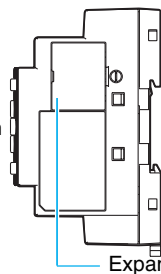

Expansion Unit connector cover.  
(See note.)  
Remove this cover to connect Expansion Unit.

**Note** Economy-type CPU Units do not have an Expansion Unit connector. Do not remove the Expansion Unit connector cover on these CPU Units.

#### Models with 20 I/O Points

Left Side

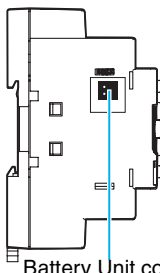

Battery Unit connector  
(Remove the seal when connecting the Battery Unit.)

Front  
Power supply terminals    Input terminals

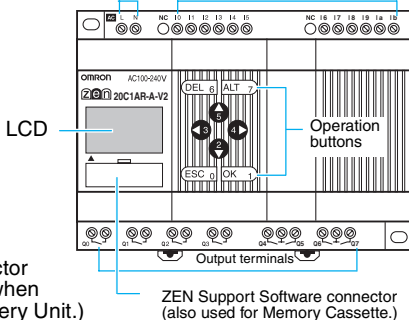

Right Side

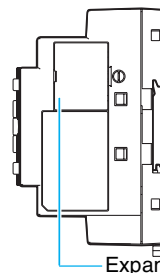

Expansion Unit connector cover.  
Remove this cover to connect Expansion Unit.

**Note** Economy-type CPU Units do not have an Expansion Unit connector. Do not remove the Expansion Unit connector cover on these CPU Units.

Display Screen and Operation Button

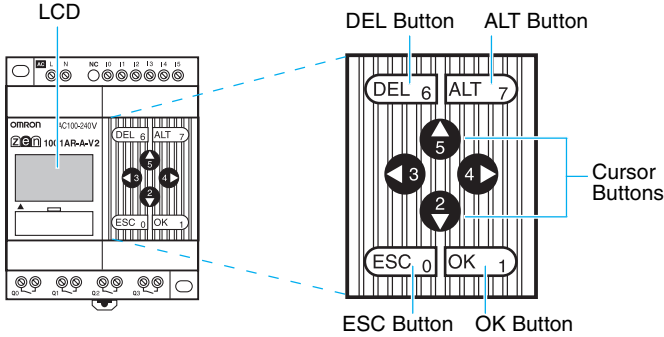









Icon Meanings



Icon	Meaning
RUN	Displayed while in RUN mode.
ERR	Indicates an error.
▲	Displayed when there is a higher-level menu or ladder program line than the one currently displayed.
▼	Displayed when there is a lower-level menu or ladder program line than the one currently displayed.
○—	Displayed when a password has been set.



Operation Button Names and Operations

Button	Function			
	Menus	Writing ladder program	Setting parameters	Button switch (See page 99.)
 DEL	---	Deletes inputs, outputs, connection lines, and blank lines.	---	B6 ON
 ALT	---	Switches between normally open and normally closed conditions. Changes to connection line write mode. Inserts a line.	---	B7 ON
 Up	Moves the cursor up and down.	Moves the cursor up and down. Selects bit types and functions.	Moves the cursor up and down. Changes numerals and parameters.	B5 ON
 Down				B2 ON
 Left	---	Moves the cursor right and left.	Moves the cursor right and left.	B3 ON
 Right				B4 ON
 ESC	Returns to the previous screen.	Cancels the setting and returns to the previous operation.	Cancels the setting and returns to the previous operation.	B0 ON
 OK	Selects the menu item at the cursor position.	Confirms the setting.	Confirms the setting.	B1 ON

## LED-type CPU Units without Display

### Models with 10 I/O Points

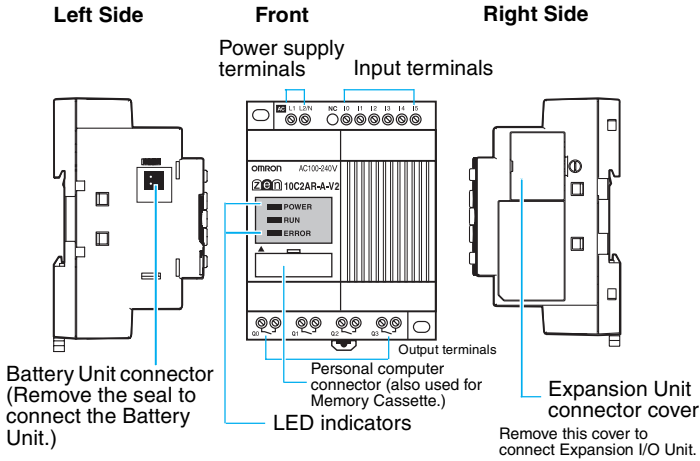

### LED Indicators

Name	Color	Meaning	
POWER	Green	Lit	Power supplied
		Not lit	No power
RUN	Green	Lit	Operating (RUN)
		Not lit	Stopped (STOP)
ERROR	Red	Lit	Error
		Not lit	Normal

Models with 20 I/O Points

Left Side

Front

Right Side

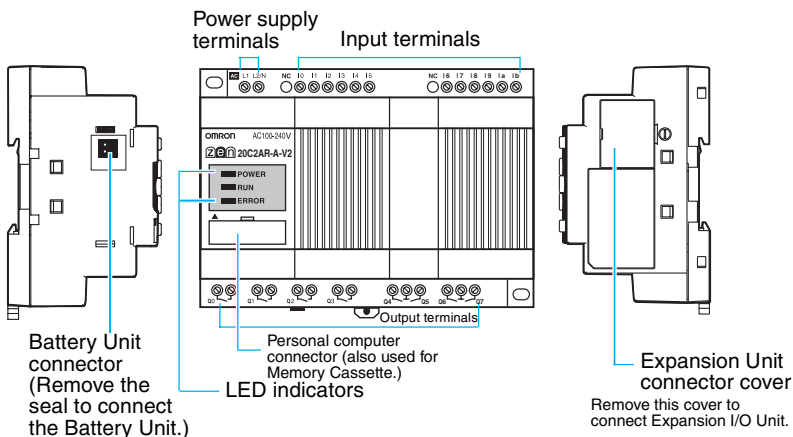

LED Indicators

Name	Color	Meaning	
POWER	Green	Lit	Power supplied
		Not lit	No power
RUN	Green	Lit	Operating (RUN)
		Not lit	Stopped (STOP)
ERROR	Red	Lit	Error
		Not lit	Normal

Expansion I/O Units

Left Side

Front

Right Side

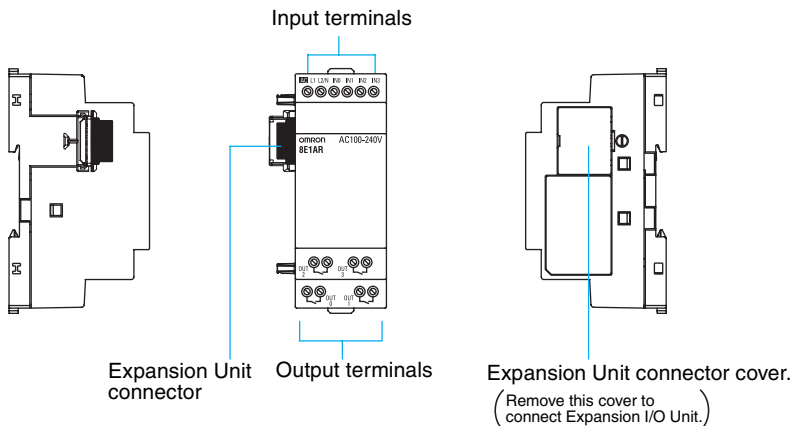

### 1-3-2 Screen Transitions

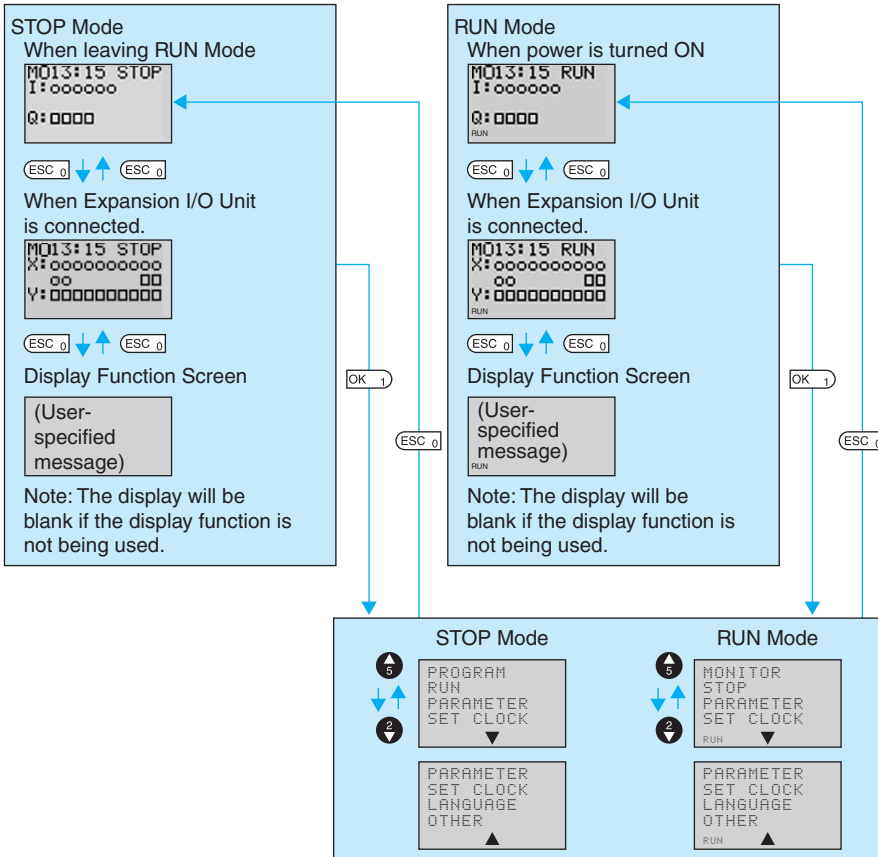

## Display Screens

### Main Screen

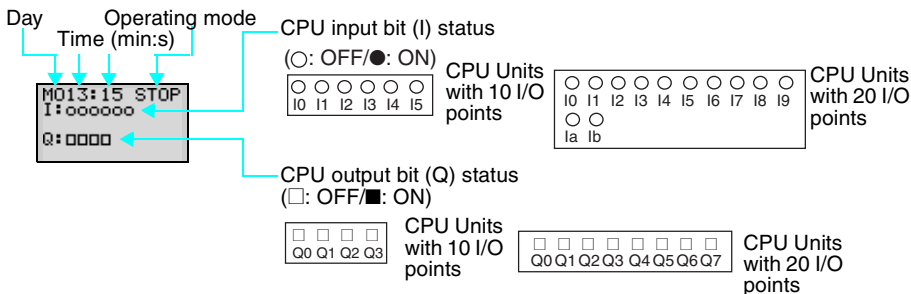

### When One or More Expansion I/O Units Are Connected

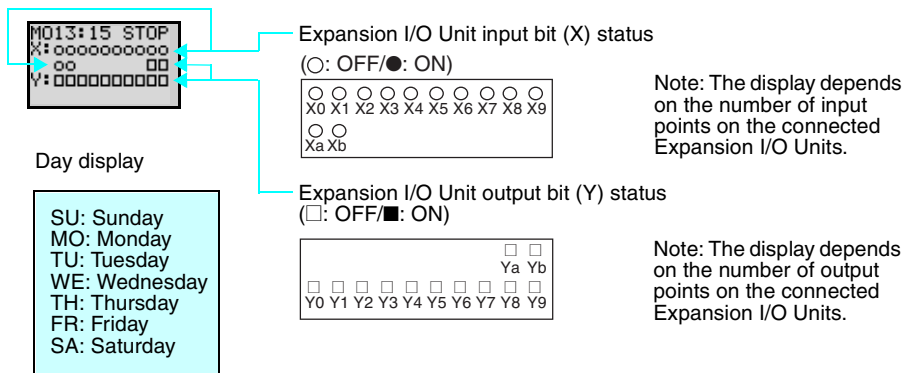

### Menu Screen Configuration

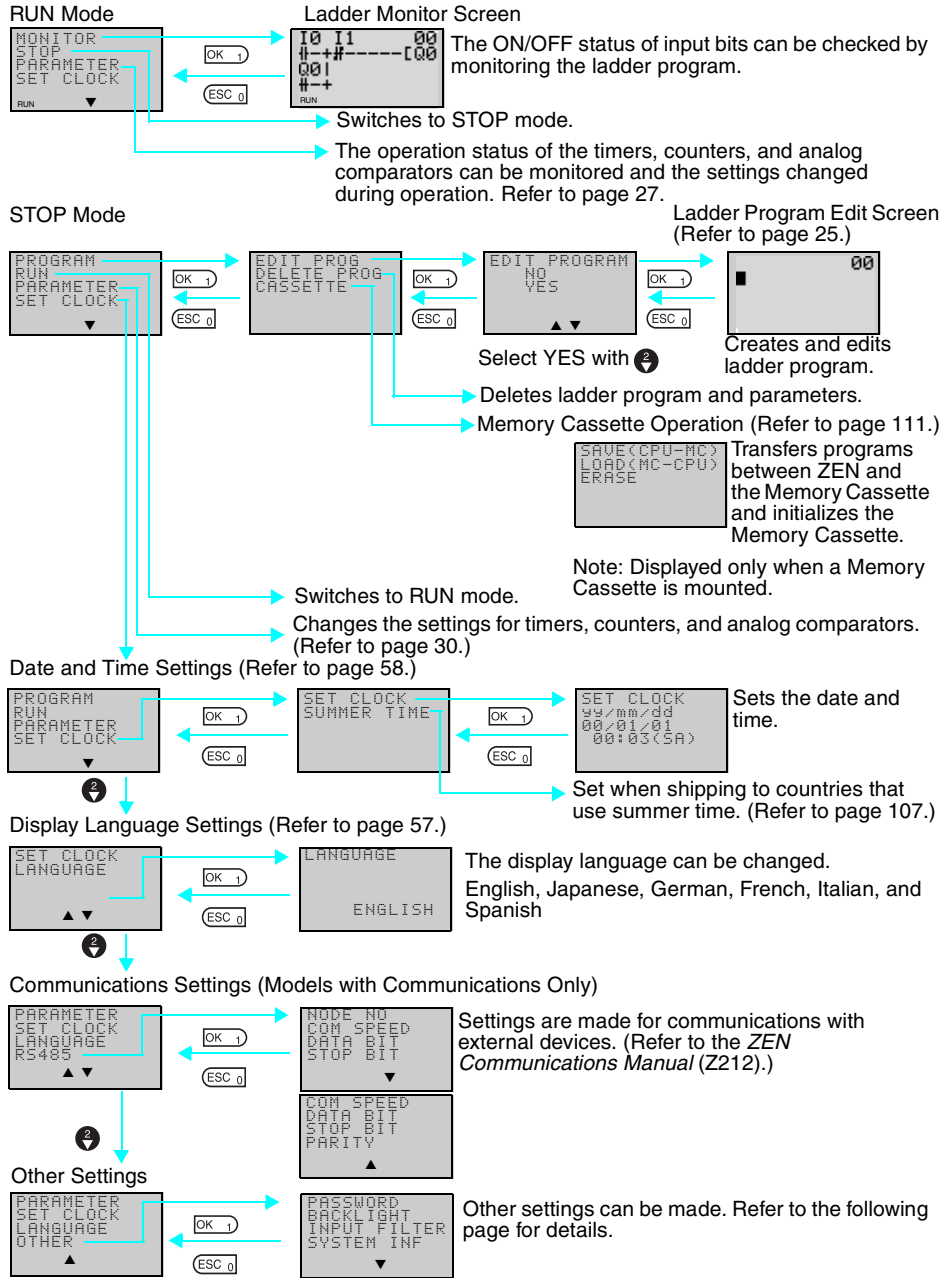

Other Submenus

```

PASSWORD
BACKLIGHT
INPUT FILTER
SYSTEM INF
▼
BACKLIGHT
INPUT FILTER
SYSTEM INF
MODEM INT
▲
    
```

Setting Passwords (Refer to page 102.)

```

PASSWORD
0000
    
```

Set a password when you want to protect programs from being read. The password setting range is 0000 to 9999.

Changing Cutout Time for Backlight (Refer to page 106.)

```

BACKLIGHT
2min
    
```

Set the automatic cutout time for the backlight in the LCD screen.  
2 min, 10 min, 30 min, Always ON

Setting Input Filters (Refer to page 104.)

```

INNER
EXP1
EXP2
EXP3
ON
    
```

Set the input filters to ON or OFF for the CPU Unit or Expansion I/O Units. Set to ON when noise or chattering may affect operation.  
“EXP1” to “EXP3” will be displayed depending on the number of Expansion I/O Units connected.

Reading System Information (Refer to page 108.)

```

U03.00
060201
INT: I06004
EX1: I04004
▼
EX2: I04004
EX3: I04004
RMT: I00000
LCD: YES
▲ ▼
RMT: I00000
LCD: YES
RTC: YES
ADC: YES
▲
    
```

Read system information, such as the CPU Unit software version or the date it was created, the number of I/O points on the CPU Unit or the Expansion I/O Units, and whether or not LCD, RTC, or analog input functions are supported.

For future expansion. Do not set.

### 1-3-3 Basic Operation

#### Menu Selection Example

Main menu display



Flashing cursor

Use the **Up/Down** Buttons to move the cursor.

OK 1

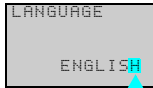

Highlighted cursor

Press the **OK** Button to select the flashing menu. The settings will flash on a reversed display.

Settings cannot be changed during reversed display.

OK 1

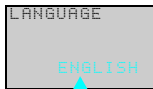

Flashing cursor

Press the **OK** Button to change from a highlighted cursor to a flashing cursor. Settings can now be changed.

Use the **Up/Down** Buttons to change the setting.

5 6



Use the **Up** Button to select **GERMAN**.

OK 1

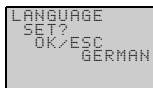

A confirmation message will be displayed asking if you want to change to German display.

OK 1



Press the **OK** Button to change from English to German.



Press the **ESC** Button to cancel the change and return to the previous screen.



**Example Operation in the Ladder Program Edit Screen**

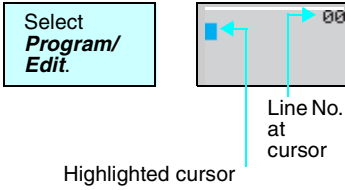

The highlighted cursor will appear in the initial write position. During highlighted cursor display, the cursor can be moved to the input or output write positions.

Up/Down Buttons: Move the highlighted cursor up and down.

Left/Right Buttons: Move the highlighted cursor Left/Right.

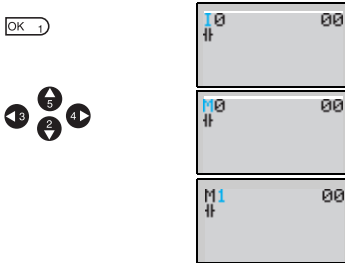

Press the **OK** Button at the input write position to display the input default setting IO and the normally open condition symbol. "I" will flash.

- Flashing Cursor at the I Position  
Up/Down Buttons: Change the bit type.  
Right Button: Moves the flashing cursor to the right.  
OK Button: Sets the bit type and moves the flashing cursor to the bit address position.
- Flashing Cursor at the 0 Position  
Up/Down Buttons: Change the bit address.  
OK Button: Completes the writing of the bit.
- Switching between Normally Open and Normally Closed Conditions  
You can use the ALT Button to switch between the N.O. and N.C. conditions, regardless of the position of the flashing cursor.



When the first input has been written, the highlighted cursor moves to the next input position.



Use the above procedure to enter program input conditions in series.



When writing serial inputs, the connecting line between inputs is drawn automatically.

ALT ↷

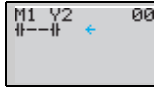

Press the **ALT** Button with the highlighted cursor in the input writing position to change the cursor to a flashing left arrow to enable connecting lines to be drawn.

Up/Down Buttons: Draw vertical connecting lines.

Left/Right Buttons: Draw horizontal connecting lines.

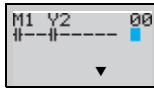

Press the **Right** Button twice to draw a line to the output bit. The cursor will change to a highlighted cursor at the output bit write position.

OK ↵

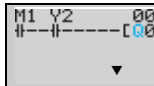

Press the **OK** Button at the output bit write position to display the default output Q. Q will flash.

- Flashing Cursor at the Q (Bit Type) Position

Up/Down Buttons: Change the type of output

Right/Left Buttons: Move the flashing cursor.

OK Button: Sets the bit type and moves the flashing cursor to the bit address position.

- Flashing Cursor at the (Additional Output Function) Position

Up/Down Buttons: Selects the additional output function

OK Button: Sets the additional output function and moves the flashing cursor to the bit address position.

- Flashing Cursor at the 0 (Bit Address) Position

Up/Down Buttons: Select the bit address

OK Button: Completes the output write.

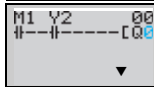

OK ↵

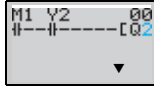

Press the **OK** Button to complete the bit write and to move the highlighted cursor to the first input position ON the next line.

OK ↵

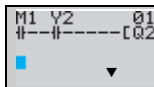

ESC ⏏

Press the **ESC** Button to complete the writing of the ladder program and to return to the menu screen.

### Example Parameter Settings Screen Operation

Select **Parameters** on menu screen.

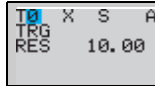

When **PARAMETER** is selected, the settings for bits that are being used by the ladder program are displayed.

#### (1) Selecting Parameters to Display

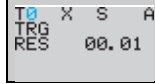

Press the **OK** Button to change the highlighted cursor to a flashing cursor.

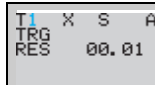

Use the **Up/Down** Buttons to select another timer.

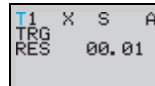

When multiple parameters of the same type have been selected, use the **Up/Down** Buttons to scroll through the numbers.

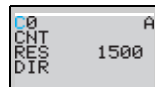

Press the **Left** Button to switch to another type, move the flashing cursor to the bit type position and use the **Up/Down** Buttons to select the bit type.

Move the flashing cursor to the bit type position and use the **Up/Down** Buttons to select another bit type.

#### (2) Setting and Changing Parameters

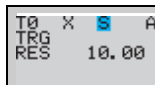
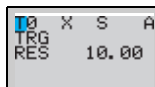

Use the **Left/Right** Buttons to move the highlighted cursor to the parameter to be set.

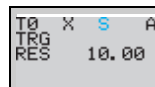

Press the **OK** Button to confirm the set position. The cursor will change to a flashing cursor.

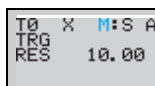

Use the **Up/Down** Buttons to set the parameter.

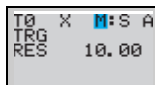

Press the **OK** Button to confirm the setting.

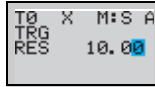

Use the **Left/Right** or **Up/Down** Buttons to move the highlighted cursor to the parameter to be set.

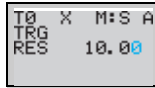

Press the **OK** Button to confirm the set position. The cursor will change to a flashing cursor.

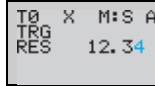

Use the **Left/Right** Buttons to select the digit to be set.

Use the **Up/Down** Buttons to change the value of each digit.

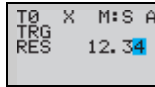

Press the **OK** Button to confirm the setting.



Press the **ESC** Button to complete the settings.

**Note** If the **ESC** Button is pressed while ladder program or parameter settings are being input, the input to that point will be canceled and the settings will return to the original settings.

# 1-4 Memory Areas

## I/O, Work, and Internal Holding Bits

Name	Type	Bit addresses	No. of bits	Function		Ladder programs	Page
CPU Unit input bits	I	0 to 5	6	CPU Units with 10 I/O pts	Reflect the ON/OFF status of the input devices connected to the CPU Unit input terminals.	N.O./N.C. inputs	32
		0 to b	12	CPU Units with 20 I/O pts			
Expansion I/O Unit input bits	X	0 to b	12	Reflect the ON/OFF status of the input devices connected to the Expansion I/O Unit input terminals.			32
Button input bits	B	0 to 7	8	Turn ON when the operation buttons are pressed in RUN mode. Cannot be used for LED-type CPU Units.			99
Analog comparator bits	A	0 to 3	4	Output the comparison result for analog inputs. Can only be used for models with a 24-VDC power supply.			87
Comparator bits	P	0 to f	16	Compare the present value of timers (T), holding timers (#), and counters (C), and outputs the comparison result.			91
8-Digit comparator bits	G	0 to 3	4	Compare the present value of 8-digit counters (F) with a constant and outputs the comparison result			94
CPU Unit output bits	Q	0 to 3	4	CPU Units with 10 I/O pts (See note 1.)	Output the ON/OFF status of the output bits to the outputs devices connected to the CPU Unit.	N.O./N.C. inputs Outputs (See note 2.)	32
		0 to 7	8	CPU Units with 20 I/O pts			
Expansion I/O Unit output bits	Y	0 to b	12	Output the ON/OFF status of the output bits to the outputs devices connected to the Expansion I/O Unit.			32
Work bits	M	0 to f	16	Can only be used within the program. Cannot output to an external device.			-
Holding bits	H	0 to f	16	Same as for work bits however the holding bits maintain ON/OFF status when power is turned OFF.			-

- Note**
1. Output bit Q3 of CPU Units with communications cannot be output externally. It can be used as a work bit.
  2. The following additional functions can be selected for bit outputs.

Execution condition

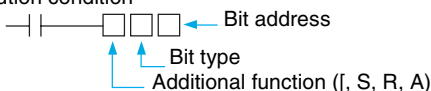

Normal output	[	Turns ON or OFF according to the ON/OFF status of the execution condition.
Set/Reset	S (set)	Holds ON status after the execution condition turns ON once.
	R (reset)	Holds OFF status after the execution condition turns ON once.
Alternate	A	Alternates between ON and OFF whenever the execution condition turns ON (input latch operation).

## Timers and Counters

Name	Type	Bit addresses	No. of timers/counters	Function	Use in ladder programs	Page
Timer	T	0 to f	16	Can be switched between ON delay, OFF delay, one-shot, flashing pulse, and twin timer operation.(See note.)	N.O./N.C. condition	74
Holding timer	#	0 to 7	8	Hold the present value during counting even if the trigger input or power supply is turned OFF. Continues the timing when the trigger input or power supply is turned ON again.		74
Counter	C	0 to f	16	Four-digit reversible counters that can be incremented and decremented.		78
8-Digit counter	F	0	1	An eight-digit reversible counter that can be incremented and decremented. CPU Units with DC power supplies support a high-speed counter up to 150 Hz.		78
Weekly timer	@	0 to f	16	Can be switched between normal operation, operation between days, and pulse output operation. Cannot be used for LED-type CPU Units.		81
Calendar timer	*	0 to f	16	Can turn ON or OFF during a specified date period. Cannot be used for LED-type CPU Units.		86

## Timer Types

X	ON delay	Times down while the trigger input is ON and turns ON the timer bit when the set time is reached.
■	OFF delay	Turns ON the timer bit while the trigger input is ON, starts timing down when the trigger input turns OFF, and turns OFF the timer bit when the set time is reached.
O	One-shot	Turns ON the timer bit for the set period when the trigger input changes from OFF to ON only.
F	Flashing pulse	Timer bit repeatedly turns ON/OFF at set intervals while the trigger input is ON.
W	Twin	Timer bit repeatedly turns ON/OFF at set intervals while the trigger input is ON. The ON time and OFF time can be set separately.

**Display Bits**

Name	Type	Bit addresses	No. of bits	Function	Use in ladder programs	Page
Display	D	0 to f	16	Display user-specified character strings, times, timer present values, counter present values, or analog-converted values. Cannot be used for LED-type CPU Units.	Output	96

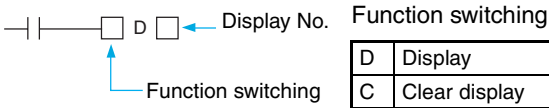

## 1-5 Allocating I/O Bit Numbers

For CPU Units with 10 I/O points, the input bit addresses I0 to I5 and output bit addresses Q0 to Q3 (Q0 to Q2 for CPU Units with communications) are always allocated to the CPU Unit.

For CPU Units with 20 I/O points, the input bit addresses I0 to Ib and output bit addresses Q0 to Q7 are always allocated to the CPU Unit.

Up to 3 Expansion I/O Units can be added and input bit addresses X0 to Xb and output bit addresses Y0 to Yb are allocated in the order the Units are connected.

### Connection Example for 4-point Expansion Input Unit, 4-point Expansion Output Unit, and 8-point Expansion I/O Unit

#### ■ CPU Units with 10 I/O Points

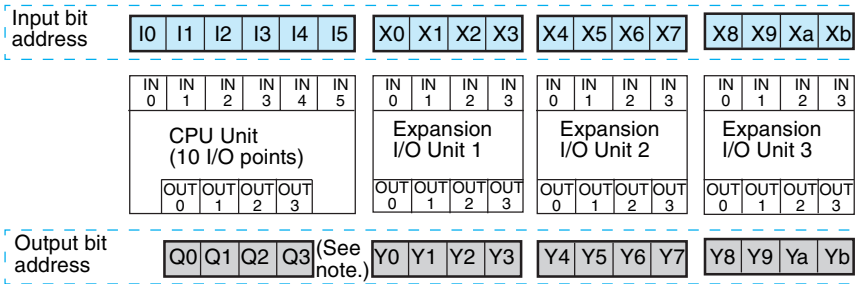

**Note** Output bit Q3 of CPU Units with communications cannot be output externally. It can be used as a work bit.

#### ■ CPU Units with 20 I/O Points

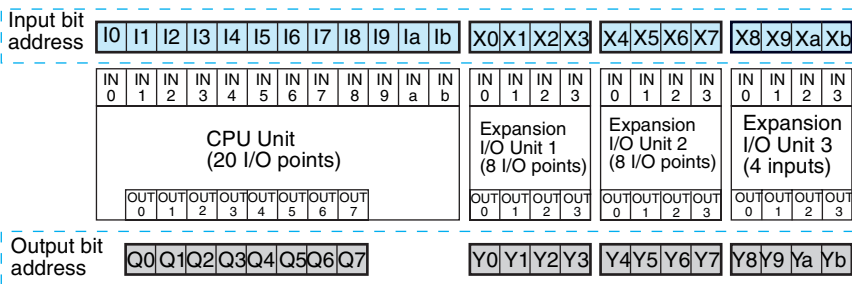



# 1-6 Preparations for Operation

## Mount ZEN to Control Panels

The ZEN can be mounted to either a DIN Track or directly onto the surface of the control panel. Refer to page 36.



## Connect Power Supply, Input, and Output Devices

Wire the ZEN to the power supply, input, and output devices. Refer to page 38.



## Make Initial Settings

Make the settings required before programming, such as date, time, and display language. Refer to pages 57 and 58.



## Write Program

Input the ladder program, including timers, counters, and other parameters. Use the ZEN Support Software when using the LED-type CPU Units (without LCD.) Refer to page 60.



## Check Program Execution

Perform trial operation before starting actual operation and check that the system is operating correctly. Refer to page 69.



## Save Program

Debugged programs and all parameters should be saved to a Memory Cassette or ZEN Support Software to prevent loss of the data. Refer to page 111.



## Actual Operation

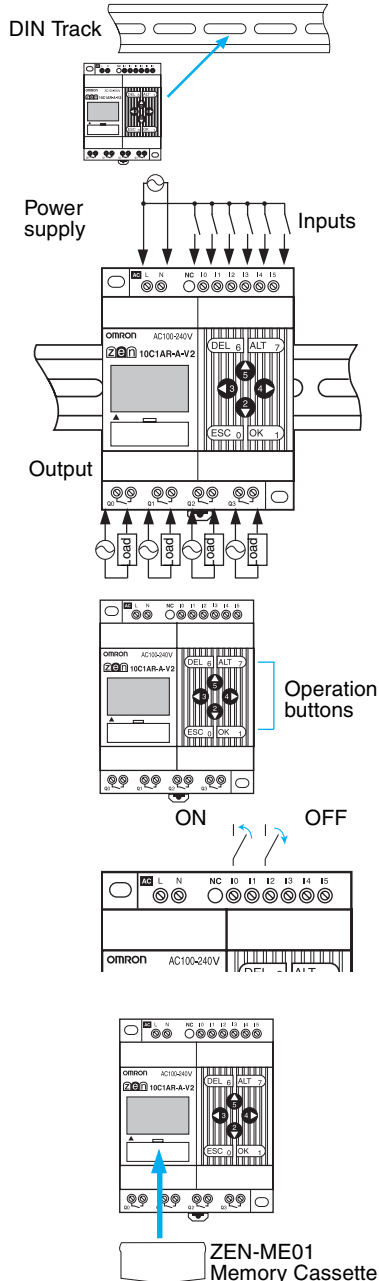



# SECTION 2

## Installation and Wiring

This section explains how to mount and wire the ZEN CPU Units and Expansion I/O Units.

2-1	Mounting	36
2-1-1	Attention: Meeting the EC Low Voltage Directive	36
2-1-2	Connecting Expansion Units	36
2-1-3	Installation Method	37
2-2	Wiring	38
2-2-1	External Wiring	38
2-2-2	Connectable Wires	40
2-2-3	Wiring Power Supply and Input Lines	40
2-2-4	Wiring CPU Units with AC Power Supplies	41
2-2-5	Wiring CPU Units with DC Power Supplies	44
2-2-6	Wiring Output Circuits	51

## 2-1 Mounting

### 2-1-1 Attention: Meeting the EC Low Voltage Directive

The ZEN is an open-structure device. The right side of the enclosure (i.e., the vertical surface where the Expansion Unit connector cover is located) does not provide the mechanical strength against impact of a 500-g, 50-mm-dia. steel ball from a height of 1,300 mm, as required in IEC/EN 61131-2. Therefore, the ZEN must always be mounted inside a control panel and the installation method must assure protection from such impact by using one of the following installation methods.

#### Protection by Cover

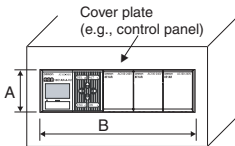

Cover Hole Dimensions

CPU Unit	A (mm)	B (mm)
CPU Unit with 10 I/O points	47	70 + N × 35 + 2
CPU Unit with 20 I/O points	47	122.5 + N × 35 + 2

N = Number of Expansion I/O Units

#### Protection by Location

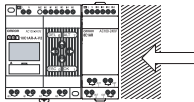

The area that needs to be protected against mechanical impact. Install the ZEN close to the wall of the control panel or in another location that will protect it from mechanical impact.

#### Protection by Barrier

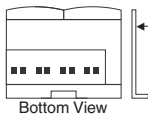

Barrier

Insert insulation between the barrier and the ZEN if the barrier is made of metal or other conductive material. If another device is used as the barrier, use a class I device.

### 2-1-2 Connecting Expansion Units

Up to 3 Expansion Units can be connected.

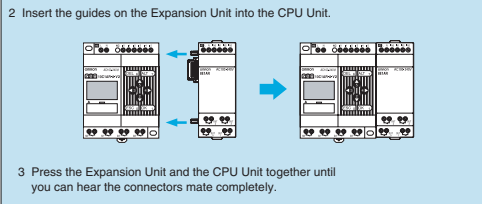
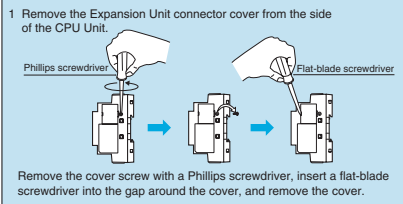

#### CAUTION

Electrical shock may occur. Do not remove the Expansion Unit connector cover unless an Expansion Unit will be permanently installed.



### 2-1-3 Installation Method

Always mount the ZEN inside a control panel. The ZEN can either be mounted to the surface of the control panel or onto a DIN Track.

#### Mounting Direction

Standard (Vertical) installation

Horizontal installation

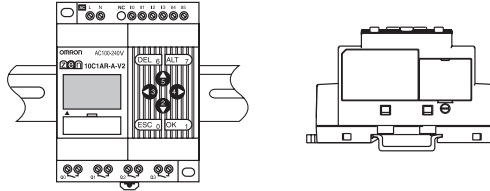

#### Mounting to DIN Track

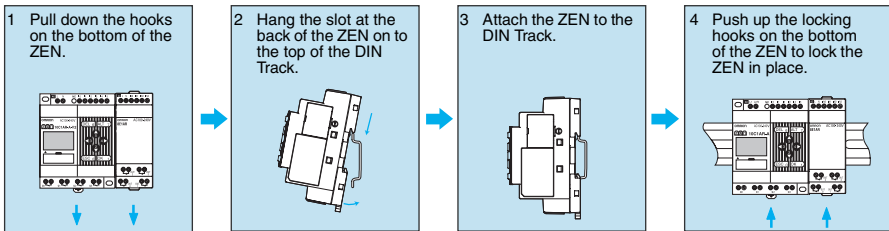

- Use DIN Track with a width of 35 mm (OMRON model PFP-50N, PFP-100N, or PFP-100N2).
- Use End Plates (OMRON model PFP-M) to secure the ZEN on the DIN Track.

## Surface Mounting

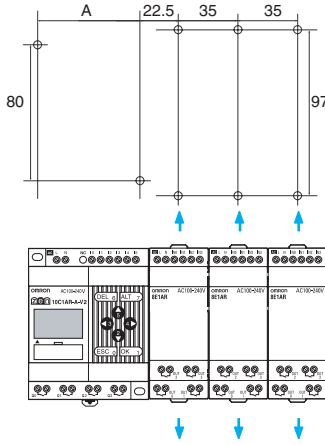

Unit	A	Screw size	Tightening torque
CPU Units with 10 I/O Points	60	M4	1.03 N·m max.
CPU Units with 20 I/O Points	112.5		
Expansion I/O Units	---	M3	0.46 N·m max.

With an Expansion Unit, pull out the DIN Track mounting hooks on the top and bottom of the Unit to secure the Unit with screws.

## 2-2 Wiring

### 2-2-1 External Wiring

Do not run ZEN I/O lines in the same duct or conduit as power lines.

#### ■ Hanging Ducts

Leave at least 300 mm between the power cables and the I/O or control wiring, as shown in the following diagram.

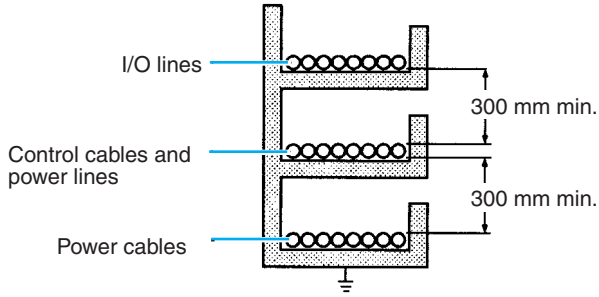

■ **Floor Ducts**

Leave at least 200 mm between the wiring and the top of the duct, as shown in the following diagram.

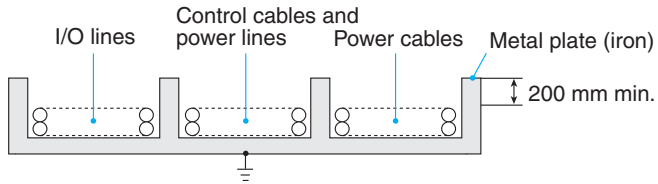

■ **Conduits**

Separate the ZEN I/O lines, power and control lines, and power cables, as shown in the following diagram.

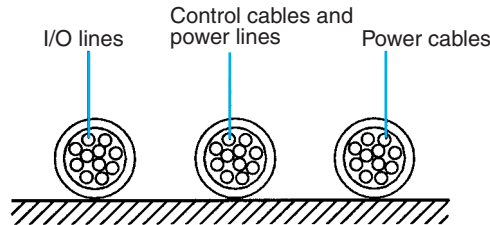

Do not run ZEN I/O lines in the same duct or conduit as power lines.

### 2-2-2 Connectable Wires

One-line connection	0.2 to 2.5 mm <sup>2</sup> (Equivalent to AWG24 to AWG14)
Two-line connection	0.2 to 0.75 mm <sup>2</sup> (Equivalent to AWG24 to AWG19)

**Note** When using a 2-line connection, use wires of the same size for both lines.

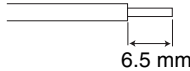

- Strip the sheath back 6.5 mm.



**Note** When using a 2-line connection, use terminals of the same size for both lines.

- Use a flat-blade screwdriver to tighten the terminal block screws and tighten the screws to a torque of 0.565 to 0.6 N·m (5 to 5.3 in-lb).
- Recommended screwdriver: SZS0.6X3.5 or SZF1-0.6X3.5 manufactured by Phoenix Contact

### 2-2-3 Wiring Power Supply and Input Lines

 <b>CAUTION</b>	
Fires may occasionally occur. Tighten the terminal block screws to a torque of 0.565 to 0.6 N·m (5 to 5.3 in-lb).	

#### || Precautions for Correct Use ||

- Do not use terminals that are not connected as relay terminals.



## 2-2-4 Wiring CPU Units with AC Power Supplies

### ■ Wiring the CPU Unit Power Supply

- To prevent voltage drops due to starting currents and inrush currents in other devices, wire the ZEN power supply circuit separately from other power circuits.
- When using more than one ZEN, to prevent voltage drops due to inrush current and circuit-breaker malfunctions, it is recommended that each one is wired separately.
- To prevent the influence of noise from power lines, twist the power lines. Wiring via a 1-to-1 isolation transformer is also effective.
- Use wires that are thick enough to allow for voltage drops and current variations within the allowable range.
- Include a circuit protector or breaker installed separately from other circuits in the power supply circuit for the ZEN.

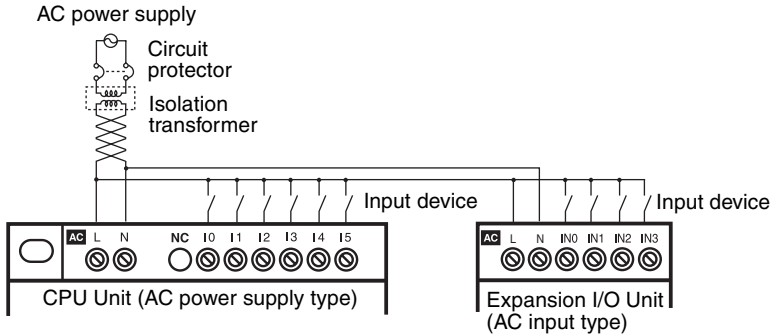

### Power Supply and Input Circuits

#### CPU Units and Expansion I/O Units with 10 I/O Points

100 to 240 VAC, 50/60 Hz

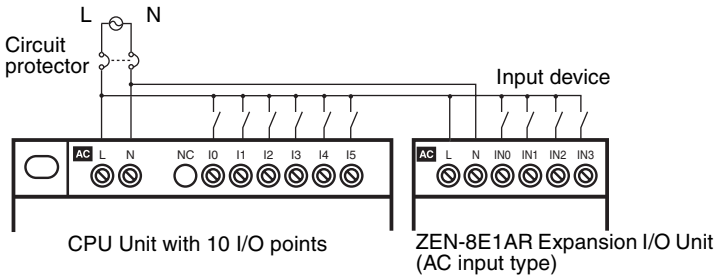

**CPU Units with 20 I/O Points and Expansion I/O Units**

100 to 240 VAC, 50/60 Hz

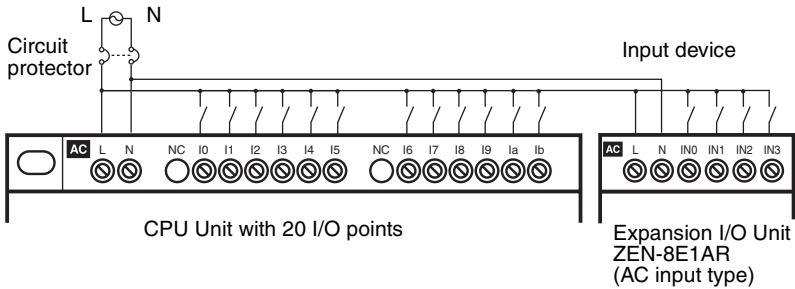

**Connecting Expansion I/O Units with DC Inputs**

100 to 240 VAC, 50/60 Hz

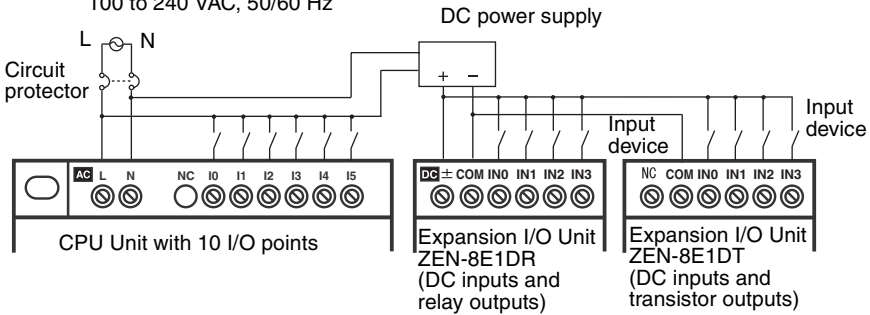

**|| Precautions for Safe Use ||**

- Supply power to both the CPU Unit and Expansion I/O Units from the same power supply and turn them ON and OFF at the same time.
- When connecting Expansion I/O Units with DC inputs to a CPU Unit with an AC power supply, the burst noise immunity will be 1 kV (IEC 61000-4-4).

**|| Precautions for Correct Use ||**

- Input circuit commons are internally connected to the N terminal of the power circuit for CPU Units with AC power supplies. Input circuit commons are internally connected to the N terminal of the power circuit for Expansion I/O Units with AC power supplies. Wire the L terminal to the power supply of the input device.

Connecting 2-Wire AC Sensors

A two-wire sensor cannot be connected directly to the AC input. To connect a two-wire sensor, attach an external bleeder resistance in the way shown below.

- Example: Connecting to a CPU Unit or Expansion I/O Unit

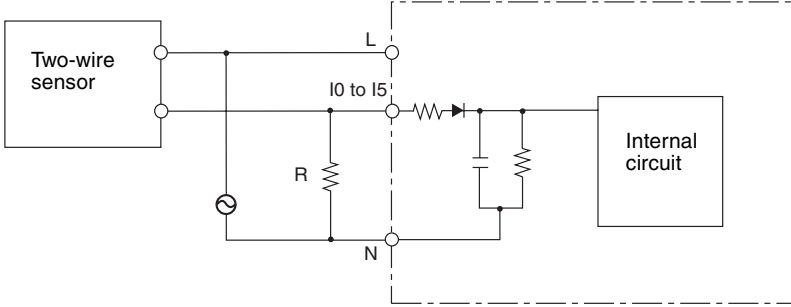

- a) Use a resistance that satisfies both of the following conditions.

$$R1 (\Omega) \leq \frac{\text{Max. OFF-voltage for AC input (25 VAC)}}{\text{Sensor's max. leakage current (A)}}$$

$$R2 (\Omega) \leq \frac{\text{Voltage supplied to sensor (V)}}{\text{Min. current for which the sensor's OFF residual voltage is less than 25 V (A)}}$$

- b) Because of heat generation, use a resistor with at least the following wattage.

$$P (W) \geq \frac{(\text{Voltage supplied to sensor})^2}{\text{Resistance value}} \times 3 \text{ (allowance factor)}$$

**Note** Calculating the Bleeder Resistance when Connecting an OMRON E2E-X10Y 2-Wire AC Sensor

This calculations in this example are based on an input voltage of 85 to 110 V AC.

The following values are from the Sensor datasheet.

The Sensor's maximum leakage current is 1.7 mA.

The minimum current when the Sensor's OFF residual voltage is

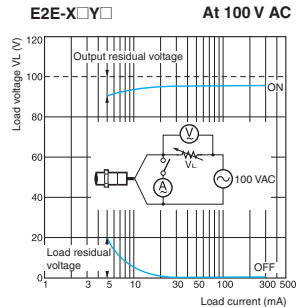

25 V or less (i.e., the OFF voltage for the ZEN) is 5 mA, as shown in the residual voltage characteristic graph.

From the formulas given above,

$$R1 \leq 25 \text{ V AC} / 1.7 \text{ mA} = 14.7 \text{ k}\Omega$$

$$R2 \leq 85 \text{ V AC} / 5 \text{ mA} = 17 \text{ k}\Omega$$

The bleeder resistor must thus be 14 kΩ.

The Sensor output current in this case would be 100 VAC/14 kΩ, or 7 mA. This satisfies the Sensor's control output range of 5 to 300 mA.

The bleeder resistor capacity is calculated as shown below and must be 3 W.

$$P \geq (110 \text{ V AC}^2) / 14 \text{ k}\Omega \times 3 = 2.59 \text{ W}$$

## 2-2-5 Wiring CPU Units with DC Power Supplies

### Power Supply and Input Circuits

#### ■ CPU Units with 10 I/O Points

##### Connecting a Negative Common (PNP Connection)

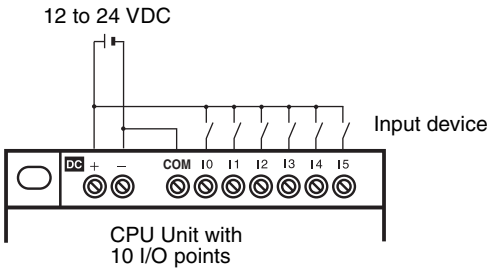

##### Connecting Analog Input Devices to Input Terminals 14 and 15

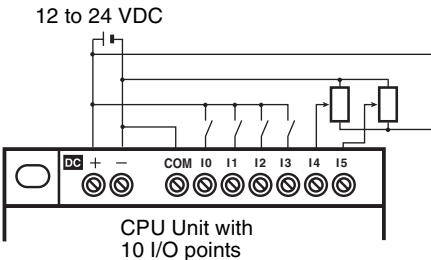

Note: When connecting an analog input device, always connect the negative side to the COM terminal.

**Connecting Positive Common (NPN Connection)**

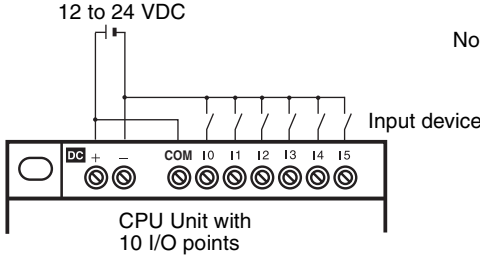

Note: If a positive common is used, analog input devices cannot be connected to 14 and 15.

**|| Precautions for Correct Use ||**

- Apply the power supply voltage through a relay or switch in such a way that the voltage reaches the rated value within 4 s. If the voltage is applied gradually, the power may not be reset or unstable output operations may result.
- Connect the COM terminals before turning ON the power supply. Not connecting the COM terminals or connecting them after turning ON the power supply may cause malfunctions.

**■ CPU Units with 20 I/O Points**

**Connecting a Negative Common (PNP Connection)**

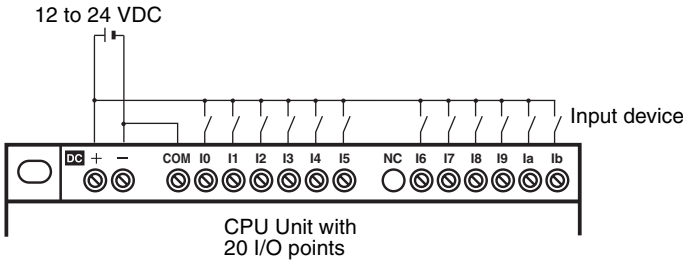

**Connecting Analog Input Devices to Input Terminals Ia and Ib**

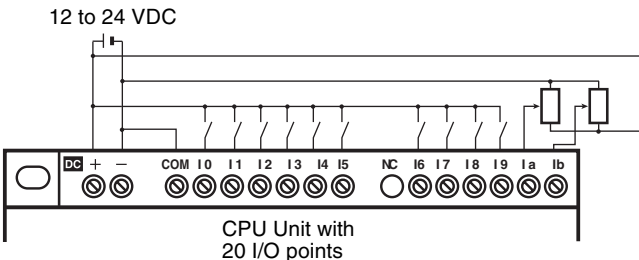

Note: When connecting an analog input device, always connect the negative side to the COM terminal.

**Connecting Positive Common (NPN Connection)**

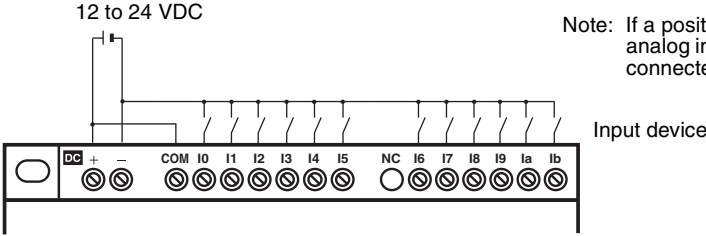

**Precautions for Correct Use**

- Apply the power supply voltage through a relay or switch in such a way that the voltage reaches the rated value within 4 s. If the voltage is applied gradually, the power may not be reset or unstable output operations may result.
- Be sure to connect COM terminal before turning ON power. The un-connecting COM terminal or the wiring change after turning ON power may cause malfunction.

**Expansion I/O Units**

**Connecting a Negative Common**

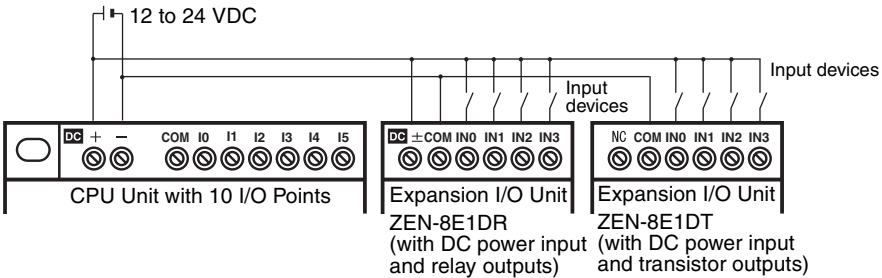

**Connecting Positive Common**

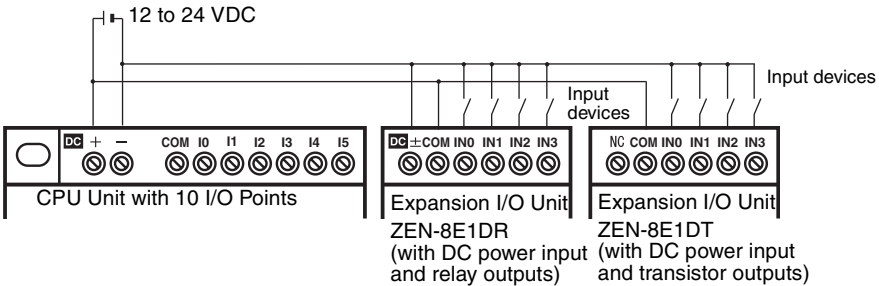

**|| Precautions for Safe Use ||**

- Supply power to both the CPU Unit and Expansion I/O Units from the same power supply and turn them ON and OFF at the same time.
- Expansion I/O Units with AC inputs (ZEN-8E1AR) cannot be connected to a CPU Unit with a DC power supply.

**|| Precautions for Correct Use ||**

- The input common for Expansion I/O Units with relay outputs (ZEN-8E1DR) is internally connected to one side of the power supply circuit (COM terminal).
- A power supply does not need to be connected to Expansion I/O Units with transistor outputs (ZEN-8E1DT).

Connecting Input Devices to the CPU Unit

The following table shows how to connect various input devices.

Device	Circuit diagram
Relay output	
NPN open collector	
NPN current output	<p>Use the same power supply for the input and sensor.</p>
PNP current output	
Voltage output	

**Note** Do **not** use the following wiring with voltage-output devices:

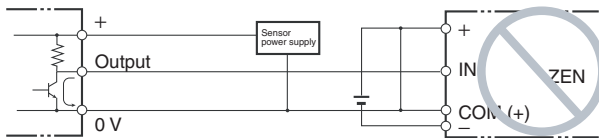

■ **Leakage Current from Input Devices**

A leakage current can cause false inputs when using 2-wire DC sensors (proximity switches or photoelectric switches) or limit switches with LEDs. False inputs won't occur if the leakage current is



less than 0.8 mA. If the leakage current exceeds this value, insert a bleeder resistor in the circuit to reduce the input impedance, as shown in the following diagram.

**Note** The OFF voltage of the analog/digital input terminals on the CPU Unit is 30 V DC. A 2-wire DC sensor can not be connected.

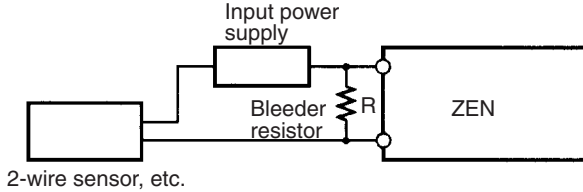

- I: Device's leakage current (mA)
- R: Bleeder resistance (kΩ)
- W: Bleeder resistor's power rating (W)
- L<sub>C</sub>: ZEN's input impedance (kΩ)
- I<sub>C</sub>: ZEN's input current (mA)
- E<sub>C</sub>: ZEN's OFF voltage (V) = 5.0 V

$$R = \frac{L_C \times 5.0}{I \times L_C - 5.0} \text{ k}\Omega \text{ max.} \quad W = \frac{2.3}{R} \text{ W min.}$$

The equations above were derived from the following equations:

$$I \times \frac{R \times \frac{\text{Input voltage (24)}}{\text{Input Current (I}_C)}}{R + \frac{\text{Input voltage (24)}}{\text{Input Current (I}_C)}} \leq \text{OFF voltage (E}_C: 5.0)$$

$$W \geq \frac{\text{Input voltage (24)}}{R} \times \text{Input voltage (24)} \times \text{tolerance (4)}$$

Refer to page 123 *Input Specifications* for details on the values L<sub>C</sub>, I<sub>C</sub>, and E<sub>C</sub>. The input impedance, input current, and OFF voltage may vary depending on the input being used.

**■ Inductive Loads**

When connecting an inductive load to an input, connect a diode in parallel with the load. The diode should satisfy the following requirements:

**1,2,3...**

1. Peak reverse-breakdown voltage must be at least 3 times the load voltage.
2. Average rectified current must be 1 A.

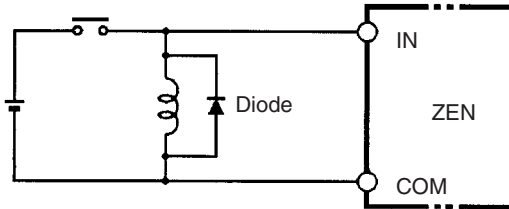

## 2-2-6 Wiring Output Circuits

### (1) Relay Output Type

For CPU Units with 10 I/O points and Expansion I/O Units, all 4 outputs in the relay output circuits have independent contacts. For CPU Units with 20 I/O points, outputs Q0 to Q3 in the relay output circuit have independent contacts and outputs Q4 to Q7 have 2 points per common.

There are no restrictions on polarity.

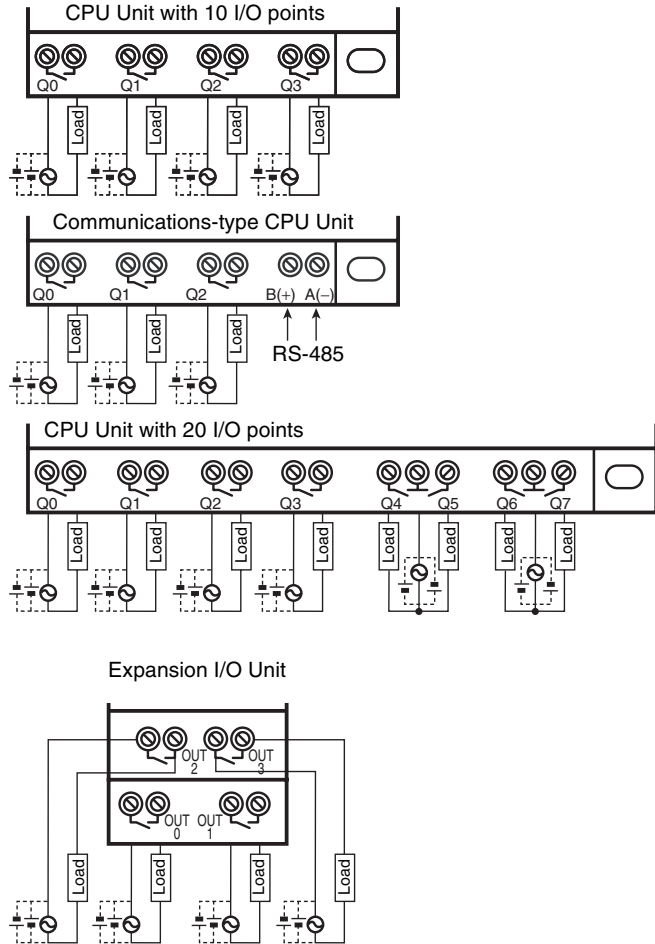

(2) Transistor Output Type

For CPU Units with 10 I/O points and Expansion I/O Units, all 4 outputs in the transistor output circuits have independent circuits. The terminals of output have polarity given on the terminal block, but no problem will result from reversing the connection positions of the power supply and load.

For CPU Units with 20 I/O points, outputs Q0 to Q3 in the transistor output circuits have independent circuits and outputs Q4 to Q7 have 2 points per common. The terminals of output Q0 to Q3 have polarity given on the terminal block, but no problem will result from reversing the connection positions of the power supply and load.

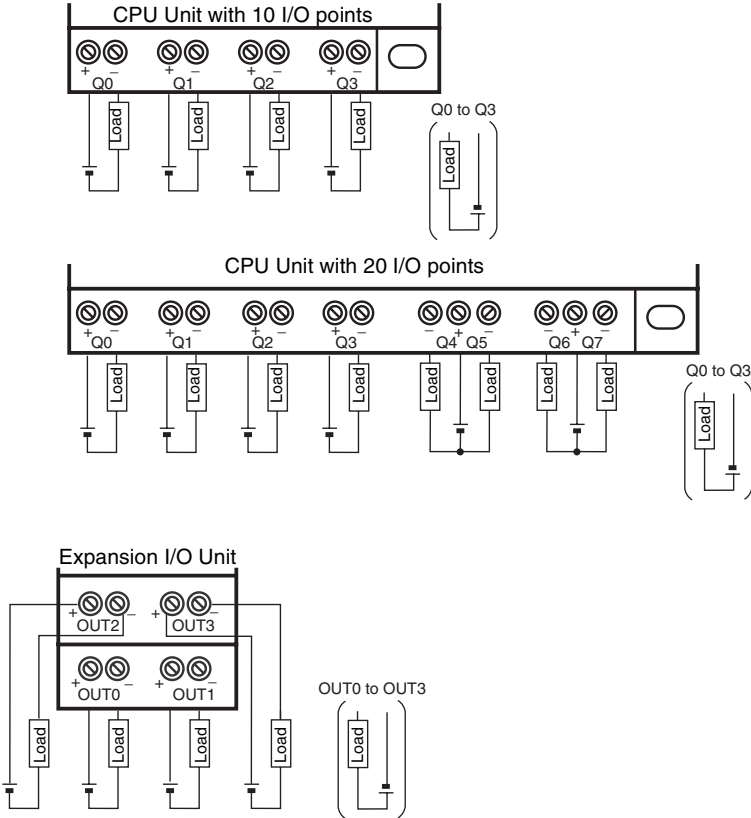

|| Precautions for Correct Use ||

- Do not exceed a cable length of 10 m when connecting transistor outputs.

## Output Wiring Precautions

### (1) Output Short Circuit Protection

We recommend adding a protective fuse to all output circuits to protect the output elements and PCBs from burning if the load connected to the output terminal short-circuits.

### (2) Inductive Loads

When connecting an inductive load to an input, connect a surge protector or diode in parallel with the load.

The surge protector's components should have the following ratings:

#### Relay Output

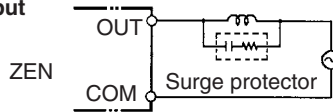

#### Relay Output (Transistor Output)

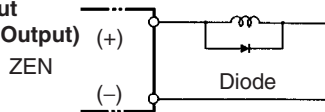

#### Relay Output (Transistor Output)

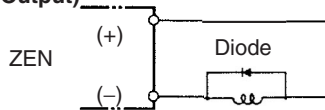

The diode should satisfy the following requirements:

Peak reverse-breakdown voltage must be at least 3 times the load voltage.

Average rectified current must be 1 A.

**(3) Inrush Current Considerations**

When switching a load with a high inrush current in the ZEN relay output or transistor output model, such as an incandescent lamp, suppress the inrush current as shown below.

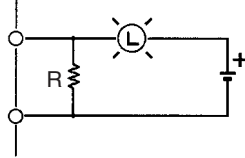
**Countermeasure 1**

Providing a dark current of approx. one-third of the rated value through an incandescent lamp

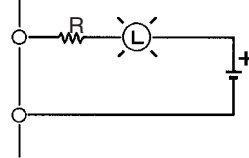
**Countermeasure 2**

Providing a limiting resistor

**(4) Fuse Insertion**

The ZEN with transistor output may burn if the load is short-circuited, therefore, insert a protective fuse in series to the load.

# SECTION 3

## Programming and Operating Methods

This section explains how to create and edit ladder programs and how to use the timers, counters, comparators, display function and buttons switches.

3-1	Selecting Display Language	57
3-2	Setting the Date and Time	58
3-3	Creating Ladder Programs	60
3-3-1	I/O Wiring and Internal Operation	60
3-3-2	Clearing Programs	60
3-3-3	Writing Ladder Programs	61
3-4	Confirming Ladder Program Operation	69
3-5	Correcting Ladder Programs	71
3-5-1	Changing Inputs	71
3-5-2	Changing Additional Bit Output Functions	71
3-5-3	Deleting Inputs, Outputs, and Connection Lines	72
3-5-4	Inserting Lines	72
3-5-5	Deleting Blank Lines	73
3-6	Using Timers (T) and Holding Timers (#)	74
3-6-1	Settings in the Ladder Program Edit Screen	76
3-6-2	Settings in the Parameter Settings Screen	76
3-6-3	Parameter Monitor Screen Display	77
3-7	Using Counters (C) and the 8-Digit Counter (F)	78
3-7-1	Settings in the Ladder Program Edit Screen	78
3-7-2	Settings in the Parameter Settings Screen	79
3-7-3	Parameter Monitor Screen Display	80
3-8	Using Weekly Timers (@)	81
3-8-1	Settings in the Ladder Program Edit Screen	82
3-8-2	Settings in the Parameter Settings Screen	83
3-8-3	Parameter Monitor Screen Display	85
3-9	Using Calendar Timers (*)	86
3-9-1	Settings in the Ladder Program Edit Screen	86
3-9-2	Settings in the Parameter Settings Screen	86
3-9-3	Parameter Monitor Screen Display	87
3-10	Analog Inputs (Analog Comparators (A))	87
3-10-1	Settings in the Ladder Program Edit Screen	89
3-10-2	Settings in the Parameter Settings Screen	89
3-10-3	Parameter Monitor Screen Display	90
3-11	Comparing Timer/Counter Present Values Using Comparators (P)	91
3-11-1	Settings in the Ladder Program Edit Screen	91
3-11-2	Settings in the Parameter Settings Screen	92
3-11-3	Parameter Monitor Screen Display	93
3-12	Comparing the 8-Digit Counter (F) Present Value Using 8-Digit Comparators (G)	94
3-12-1	Settings in the Ladder Program Edit Screen	94
3-12-2	Settings in the Parameter Settings Screen	94
3-12-3	Parameter Monitor Screen Display	95

3-13	Displaying Messages (Display Bits (D))	96
3-13-1	Settings in the Ladder Program Edit Screen	96
3-13-2	Settings in the Parameter Settings Screen	97
3-14	Using Button Input Bits (B)	99



### 3-1 Selecting Display Language

There is a choice of 6 display languages. The default language is English.

#### Operation to Select German

Turn ON the power.

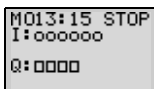

Press the **OK** Button to change to the Menu Screen.



Press the **Down** Button 4 times to move the cursor to "LANGUAGE".

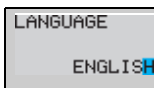

Press the **OK** Button to display the current language ("ENGLISH"). The final "H" will be highlighted and flashing.



Press the **OK** Button to make the whole word "ENGLISH" flash. A different language can now be selected.

Use the **Up/Down** Buttons to select a language.

- SPANISH  
 ↓  
 ITALIAN  
 FRENCH  
 GERMAN
- ↑  
 JAPANESE  
 ENGLISH

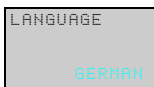

Press the **Up** Button to select **GERMAN**.

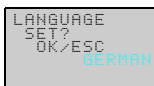

Press the **OK** Button to display a confirmation message.



Press the **OK** Button to complete the setting. The display language will change to German.

## 3-2 Setting the Date and Time

The date and time are not set when the product is shipped. The date and time must be set before the ZEN can be used. LED-type CPU Units (ZEN-□0C2□□-□-V2) do not have a calendar and clock function.

Select **SET CLOCK**.

```
PROGRAM
RUN
PARAMETER
SET CLOCK
```

OK 1

```
SET CLOCK
SUMMER TIME
```

Press the **OK** Button to display the submenu for clock settings. Select **SET CLOCK** from the submenu.

OK 1

```
SET CLOCK
yy/mm/dd
00/01/01
00:03(SA)
```

Press the **OK** Button to display the current date and time settings. The right digit of the date will be highlighted and flashing.

Current time: hh:mm (day)

Current date: yy/mm/dd

Days of the week

SU: Sunday  
 MO: Monday  
 TU: Tuesday  
 WE: Wednesday  
 TH: Thursday  
 FR: Friday  
 SA: Saturday

OK 1

```
SET CLOCK
yy/mm/dd
00/01/01
00:03(SA)
```

Press the **OK** Button to change from a highlighted cursor to a flashing cursor and enable data to be changed.



```
SET CLOCK
yy/mm/dd
00/04/01
11:3(SU)
```

Set the date and time.

Use the **Up/Down** Buttons to change the setting.

Use the **Left/Right** Buttons to move the cursor.

The day will automatically change when the date is set.

OK 1

```
SET CLOCK
SET?
OK/ESC
11:35(SU)
```

Press the **OK** Button to display a confirmation message.

OK 1

Press the **OK** Button to confirm and complete the setting.

### || Precautions for Correct Use ||

If the power supply is turned OFF for two days or more at 25°C, the date and time will return to the default setting (00/1/1; 00:00 (SA)).

This may cause programs using calendar timers or weekly timers to malfunction. Therefore, mount a Battery Unit for the system if the power supply is expected to be interrupted for an extended time. (Refer to page 110.)

- Note**
1. The year can be set between 2000 and 2099.
  2. If the Daylight Saving Time (DST) is set, “S” will appear at the top right of the time setting screen during the Daylight Saving Time (DST) period. (Refer to page 107.)

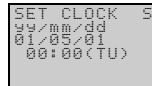

← “S” displayed during the Daylight Saving Time (DST) period

### 3-3 Creating Ladder Programs

#### Example Program

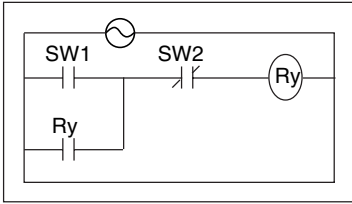

This section explains how to write ladder programs, based on a simple circuit example.

Refer to the *ZEN-SOFT01-V4 ZEN Support Software Operation Manual (Z184)* for information on programming LED-type CPU Units.

#### 3-3-1 I/O Wiring and Internal Operation

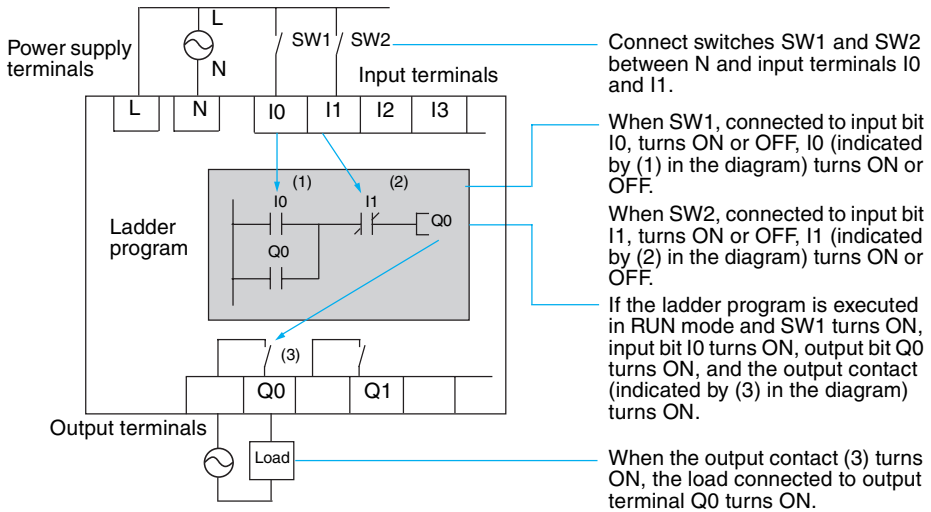

#### 3-3-2 Clearing Programs

Clear the ladder program before starting to write a program. By performing the Delete Program operation, the ladder program will be completely cleared. The display language, date/time settings, and all other settings will not be initialized.

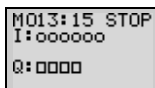
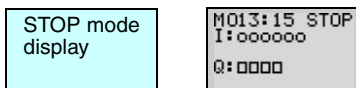

Press the **OK** Button to switch to the Menu Screen and select **PROGRAM**.

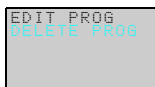

Select **DELETE PROG**.

If a password has been set, a Password Input Screen will be displayed. Input the password.

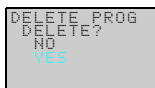

Press the **OK** Button to display a confirmation message, and then select **YES**.

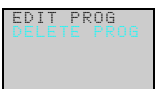

When the Delete Program operation has been completed, the display will return to the original screen.

### 3-3-3 Writing Ladder Programs

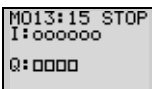
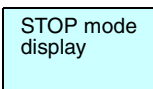

Press the **OK** Button to switch to the Menu Screen and select **PROGRAM**.



Select **EDIT PROG**.

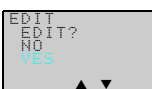

Press the **OK** Button to display a confirmation message, and then select **YES**.



Press the **OK** Button to switch to the Ladder Program Edit Screen.

Indicates the line number in the ladder program at the cursor position (line 0 in this example.)

Cursor flashing in a reversed state.

### Operations in the Ladder Program Edit Screen

Two lines of circuits can be displayed at one time on the Ladder Program Edit Screen.

Up to 96 lines can be written.

Up to 3 inputs and 1 output can be written per line.

- Example ladder diagram

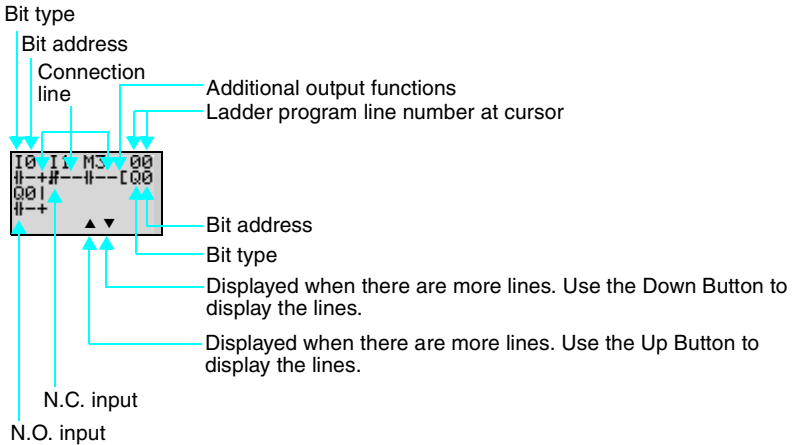

- Positions for Writing Inputs, Outputs, and Connection Lines

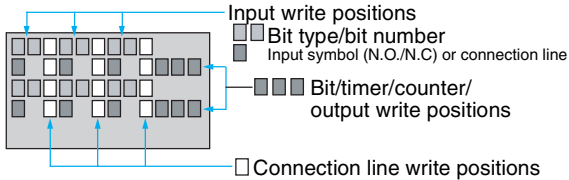

**3-3-3-1 Writing an Input for I0**

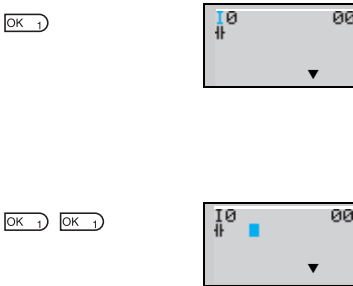

Press the **OK** Button to display the initial write setting (N.O input I0) and move the flashing cursor to the bit type I position. Use the **Up/Down** Buttons to select the bit type. Use the **Right** Button to move the flashing cursor to the 0 position and then use the **Up/Down** Buttons to select the bit address.

Press the **OK** Button twice to complete the write operation for input I0. The highlighted cursor will move the next input position.

**3-3-3-2 Writing Serial Input I1**

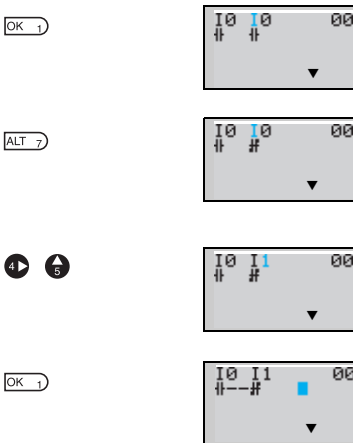

Press the **OK** Button to display the N.O. input and input I0 again.

Press the **ALT** Button to switch to a N.C. input.

(Press the **ALT** Button again to switch back to a N.O. input.)

Use the **Right** Button to move the flashing cursor to the bit address position and use the **Up** Button to change the bit address to 1.

Press the **OK** Button to move the highlighted cursor to the next input position. A connection will automatically be created between input I0 and the next input.

**Writing Inputs**

**Input Symbol Configuration**

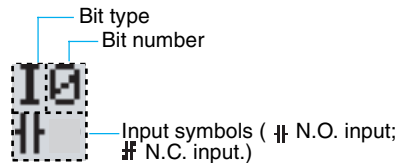

■ Memory Areas

Symbol	Name	Bit type and number
I	CPU Unit input bits	I0 to I5 (6 points) (See note 1.)
Q	CPU Unit output bits	Q0 to Q3 (4 points) (See note 2.)
X	Expansion I/O Unit input bits	X0 to Xb (12 points) (See note 3.)
Y	Expansion I/O Unit output bits	Y0 to Yb (12 points) (See note 3.)
M	Work bits	M0 to Mf (16 points)
H	Holding bits	H0 to Hf (16 points)
B	Button switches	B0 to B7 (8 points) (See note 4.)

- Note**
1. I0 to Ib (12 points) for CPU Units with 20 I/O points.
  2. Q0 to Q7 (8 points) for CPU Units with 20 I/O points. Q3 of CPU Units with communications cannot be output externally.
  3. Can be used only when Expansion I/O Units are connected.
  4. Cannot be used for LED-type CPU Units.

■ Timers, Counters, and Analog Comparators

Symbol	Name	Bit type and number
T	Timers	T0 to Tf (16 timers)
#	Holding timers	#0 to #7 (8 timers)
@	Weekly timers	@0 to @f (16 timers) (See note 1.)
*	Calendar timers	*0 to *f (16 timers) (See note 1.)
C	Counters	C0 to Cf (16 counters)
F	8-Digit counter	F0 (1 counter)
A	Analog comparators	A0 to A3 (4 comparators) (See note 2.)
P	Comparators	P0 to Pf (16 comparators)
G	8-Digit comparators	G0 to G3 (4 comparators)

- Note**
1. Can be used only when LCD-type CPU Units are used.
  2. Can be used only with CPU Units with DC power supply (PNP connection).



ALT ↷

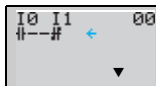

Press the **ALT** Button to enable drawing a connection line. The left arrow cursor will flash.

⏪

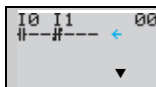

Press the **Right** Button to draw a connection line to the output.

## Writing Outputs

### Output Configuration

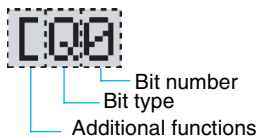

### ■ Memory Areas

Symbol	Name	Bit type and number
Q	CPU Unit output bits	Q0 to Q3 (4 outputs) (See note 1.)
Y	Expansion I/O Unit output bits	Y0 to Yb (12 outputs) (See note 2.)
M	Work bits	M0 to Mf (16 bits)
H	Holding bits	H0 to Hf (16 bits)

- Note**
1. Q0 to Q7 (8 points) for CPU Units with 20 I/O points. Q3 of CPU Units with communications cannot be output externally.
  2. Can be used only when Expansion I/O Units are connected.

### ■ Additional Functions for Output Bits

Symbol	Name
[	Normal operation
S	Set operation
R	Reset operation
A	Alternate operation

Additional Functions for Bit Outputs

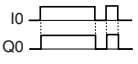
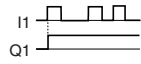
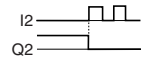
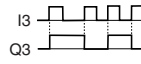
[: Normal output	S: Set	R: Reset	A: Alternate
I0-----[Q0	I1-----SQ1	I2-----RQ2	I3-----AQ3
			
Q0 turns ON and OFF when execution condition I0 turns ON and OFF.	Q1 turns ON and stays ON when execution condition I1 turns ON once.	Q2 is forced OFF when execution condition I2 turns ON.	Q3 alternates between On and OFF each time execution condition I3 turns ON.

Timers, Holding Timers, Counters, and Display Output Configurations

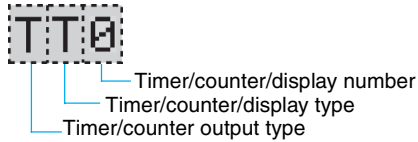

■ Timers, Counters, and Display Bits

Symbol	Name	Type and number	Output type
T	Timer	T0 to Tf (16 timers)	T: Trigger
#	Holding timer	#0 to #7 (8 timers)	R: Reset
C	Counter	C0 to Cf (16 counters)	C: Count
F	8-Digit counter	f0 (1 counter)	D: Count direction R: Reset
D	Display bit	D0 to Df (16 bits) (See note.)	D

**Note** Cannot be used for LED-type CPU Units.

3-3-3-3 Writing an Output to Q0

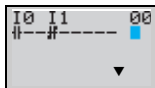

Press the **Right** Button again to draw a line to the output and move the highlighted cursor to the output write position.

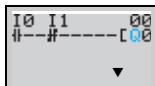

Press the **OK** Button to display the initial value for the output (normal output/Q0) and move the flashing cursor to the bit type Q position.

Use the **Up/Down** Buttons to select the bit type. Use the **Right/Left** Buttons to move the flashing cursor and use the **Up/Down** Buttons to select additional functions or select the bit address.

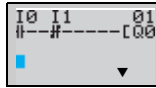

Press the **OK** Button twice to complete writing output Q0. The highlighted cursor will move to the input at the beginning of the next line.

### 3-3-3-4 Writing a Parallel Input for Q0



Press the **OK** Button to display input I0 and move the flashing cursor to the bit type I position.

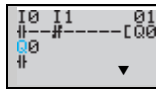

Press the **Up** Button to select **Q** (a CPU Unit output bit).



Press the **OK** Button twice to complete writing the parallel input for Q0. The highlighted cursor will move to the next input.

### 3-3-3-5 Drawing Connection Lines for OR Circuits

#### Drawing Connection Lines

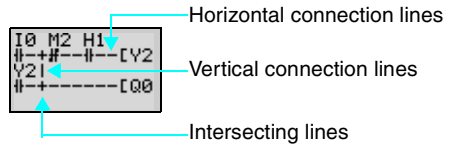

Press the **ALT** Button when the highlighted cursor is at the input write position to change the cursor to a left flashing arrow and enable connection lines to be drawn. Move the left arrow the position for drawing the connection line and press the **Up**, **Down**, **Left**, and **Right** Buttons to draw connection lines vertically and horizontally.

It will not be possible to draw connection lines, if a written input/output bit has been reached, if the beginning or end of the line has been reached, or if the OK and ESC Buttons are pressed.

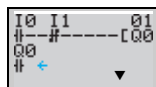

Press the **ALT** Button to enable drawing connection lines.

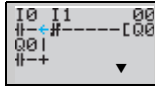

Press the **Up** Button to simultaneously draw a connection line both vertically and horizontally. The cross (+) indicates an intersection.



Press the **OK** Button to complete writing the connection line and change to a highlighted flashing cursor.



Press the **ESC** Button to complete the write operation.



Press the **ESC** Button again to return to the Menu Screen.

### || Precautions for Correct Use ||

Always press the ESC Button and return to the Menu Screen after creating a program. If you do not press the ESC Button and return to the Menu Screen before turning OFF the power, the program and settings will be deleted.

- Do not input a program where the connection lines double back on themselves. The program will not operate properly if such lines are drawn.

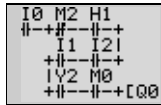

- Do not use the same output bit address for more than one output from the program. The resulting operation may not be as expected.

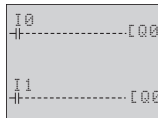

----- Here, the final status of Q0 will be controlled by I1, not by I0.

## 3-4 Confirming Ladder Program Operation

Always check the ladder program operation before using the ZEN.

### || Precautions for Safe Use ||

- Before turning ON the power, check that all wiring has been performed correctly.
- For systems with loads connected to the outputs that may cause serious injury or damage to equipment if operation is incorrect, remove the output wiring before performing trial operation.
- Always ensure safety in the vicinity before switching the operating mode (RUN/STOP).

### Procedure for Checking Operation

#### Checks Before Turning ON the Power

1. Check that the ZEN is mounted and wired correctly.
2. Check that the operation of the ZEN will not have a negative impact on the system. Check for any dangers.
3. Turn ON the power supply to the ZEN.  
The ZEN will start in RUN Mode when power is turned ON.

#### Operation Checks

4. Turn each input ON and OFF and check that the program is operating correctly.
5. Adjust any problems.

### Method for Checking Operation

- Check the operation by the flashing input and output displays on the Main Screen (not including LED-type CPU Units).
- Check the operation by using the Ladder Program Monitor (not including LED-type CPU Units).
- Connect the ZEN Support Software and check operation using the monitor function. Refer to the operation manual for the ZEN Support Software.

## Checking Operation

### Changing Operating Mode

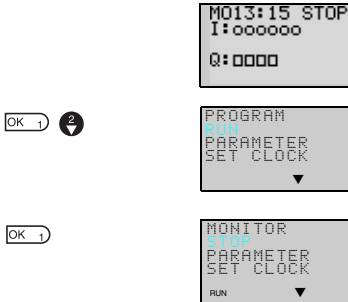

Press the **OK** Button to display the Menu Screen and press the **Down** Button to move the flashing cursor to RUN.

Press the **OK** Button to switch from STOP mode to RUN mode.

### Checking Operations on Main Screen



Press the **ESC** Button to switch to the Main Screen.

Turn I0 ON.

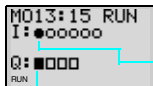

Q0 will turn ON when I0 turns ON.  
I0 ON.  
Q0 ON at the same time.

Turn I0 OFF.

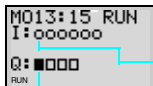

Q0 remains ON even if I0 turns OFF.  
I0 OFF.  
Q0 ON.

Turn I1 ON.

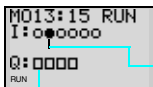

Q0 will turn OFF when I1 is turned ON.  
I1 ON.  
Q0 OFF.

### Checking Operations Using Ladder Program Monitor



Select **Monitor** in RUN mode.



Press the **OK** Button to switch to the Ladder Program Monitoring Screen.

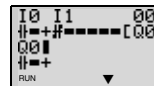

Q0 turns ON at the same time when I0 turns ON. When the bit is ON, the vertical and horizontal lines are thick.

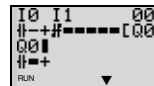

## 3-5 Correcting Ladder Programs

### 3-5-1 Changing Inputs

Move the highlighted cursor to the input to be changed.

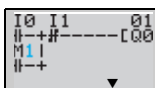
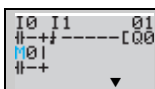
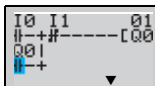

Change contact Q0 to M1.

Press the **OK** Button to change the highlighted cursor to a flashing cursor and move the flashing cursor to the bit type position.

Use the **Up/Down** Buttons to select **M**.

Press the **Right** Button to move the flashing cursor to the bit address position. Use the **Up/Down** Buttons to change the bit address from 0 to 1.

Press the **OK** Button to complete the setting change.

### 3-5-2 Changing Additional Bit Output Functions

Move the highlighted cursor to the output to be changed.

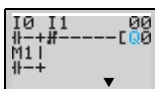

Change the additional function for the input for Q0 to S (Set).

Press the **OK** Button to change the highlighted cursor to a flashing cursor.

Press the **Left** Button to move the flashing cursor to the additional function position.

Press the **Up** Button twice to change the additional function from [ to S.

Press the **OK** Button to complete the change.

### 3-5-3 Deleting Inputs, Outputs, and Connection Lines

Move the highlighted cursor to the position of the input, output, or connection line to be deleted and press the **DEL** Button.

#### Example: Deleting Serial Input M3

Move the highlighted cursor to the position of the input to be deleted.

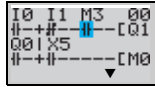

**DEL** 6



Press the **DEL** Button to delete the input and the related connecting lines at the same time.

#### Example: Deleting Vertical Connecting Lines

**ALT** 7

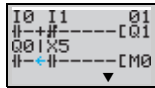

Move the highlighted cursor to the input position to the right of the vertical line to be deleted. Press the **ALT** Button to enable drawing connection lines. The highlighted cursor will change to a left arrow cursor.

**DEL** 6

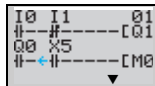

Press the **DEL** Button to delete the vertical connection line.

### 3-5-4 Inserting Lines

- To insert a blank line, move the highlighted cursor to the beginning of the line where the blank line is to be inserted and press the **ALT** Button.

Move the highlighted cursor to the beginning of the next line (the line that will be after the inserted line.)

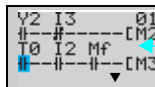

A circuit will be added here.

**ALT** 7

Blank line

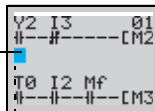

Press the **ALT** Button to insert one blank line.

- To add OR programming, inputs can be added between parallel inputs. Move the highlighted cursor to the beginning of the line where the input is to be inserted.

Move the highlighted cursor to the beginning of the next line (the line that will be after the inserted line.)

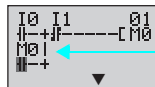

An input will be added here.



ALT 7

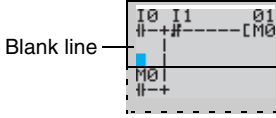

Press the **ALT** Button to reserve a 1-line space between the parallel inputs.

The vertical connection lines will be automatically extended.

**Note** A blank line cannot be inserted if an input or connection line is written in the last line (the 96th line).

### 3-5-5 Deleting Blank Lines

To delete a blank line, move the highlighted cursor to the input position at the beginning of the line to be deleted and press the **DEL** Button.

Move the highlighted cursor to the beginning of the line to be deleted.



This line will be deleted.

DEL 8

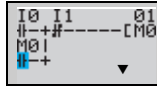

Press the **DEL** Button to delete one blank line. All following lines will move up one.

**Note** A line must be blank to be deleted, i.e., lines containing inputs and outputs cannot be deleted.

## 3-6 Using Timers (T) and Holding Timers (#)

The ZEN has 16 built-in timers and 8 built-in holding timers.

Timers	<p>The present value being timed will be reset when the timer switches from RUN mode to STOP mode or the power is turned OFF.</p> <p>There are five uses of the timer available, depending on the additional function selection.</p>
Holding timers	<p>The present value being timed is held even when the timer switches from RUN mode to STOP mode or the power is turned OFF. The time will continue when the trigger input turns ON again. The ON status of the timer bit is also held when the timer times out.</p> <p>Only ON-delay holding timers are supported.</p>

### Timer Usage and Operation

<b>X: ON delay timer</b>	
	<p>Turns ON after a set interval after the trigger input has turned ON.</p> <p><b>Basic Operation</b></p> <p><b>Main Applications</b> Time lag operations</p>
<b>■: OFF delay timer</b>	
	<p>Stays ON while the trigger input is ON and turns OFF after a set interval after the trigger input has turned OFF.</p> <p><b>Basic Operation</b></p> <p><b>Main Applications</b> Useful for timing lighting and ventilating fans.</p>

**O: One-shot pulse timer**

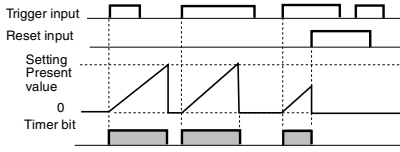

Remains ON for a set interval when the trigger input turns ON.

**Basic Operation**



**Main Applications**

Useful for fixed-quantity operation when operation is always required for the same period.

**F: Flashing pulse timer**

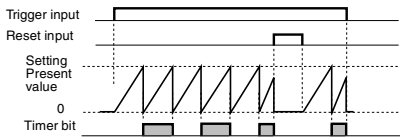

Turns ON and OFF repeatedly at set intervals while the trigger input is ON.

**Basic Operation**

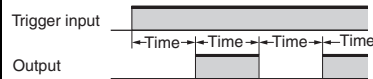

**Main Applications**

Useful as an alarm circuit for flashing emergency lighting or buzzers.

**W: Twin timer**

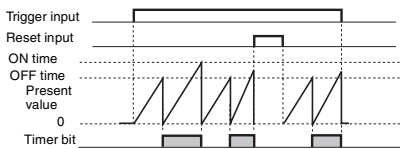

Turns ON and OFF repeatedly at set intervals while the trigger input is ON. The ON time and OFF time can be set independently.

**Basic Operation**

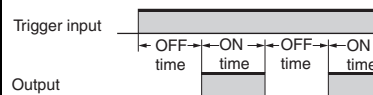

**Main Applications**

Convenient for intermittent operation, such as that used for fans.

**Holding Timer Usage and Operation**

**X: ON delay timer only**

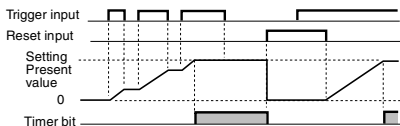

Turns ON after a set interval after the trigger input has turned ON. The present value is held while the trigger input is OFF.

**Main applications**

When operation is to be continued even during momentary power interruptions and longer power interruptions. Also used for time-lag operation.

### 3-6-1 Settings in the Ladder Program Edit Screen

Timer triggers, reset outputs, and timer inputs are drawn on the Ladder Program Edit Screen. Settings are made on the Parameter Settings Screen.

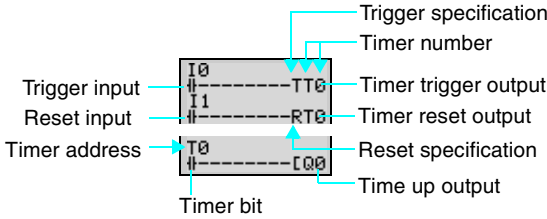

Timer address	Timers: T0 to Tf (16 timers)/ Holding Timers: #0 to #7 (8 timers)	
Trigger input	T (TRG)	Controls the timer trigger output. Triggers the timer when the trigger input turns ON.
Reset input	R (RES)	Controls the timer reset output. When the reset input turns ON, the present value is reset to 0 and the timer bit turns OFF. Trigger inputs are not accepted while the reset input is ON.
Timer bit	Turns ON according to the timer type.	

### 3-6-2 Settings in the Parameter Settings Screen

#### All Timers Except Twin Timers (X, ■, O, F)

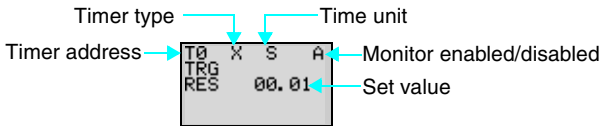

#### Twin Timers (W)

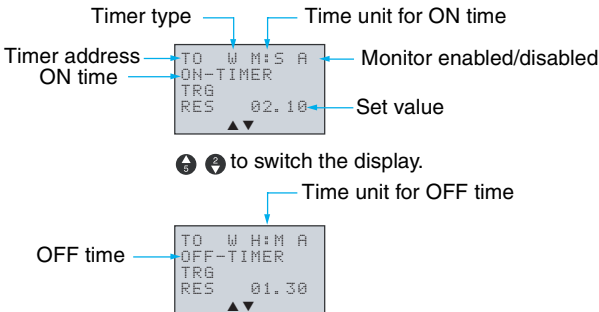

Timer Types

X	ON delay
■	OFF delay
O	One-shot pulse
F	Flashing pulse
W	Twin

Time Units and Settings

S	00.01 to 99.99 s (in 0.01-s units)
M:S	00 min 01 s to 99 min 59 s (in minutes and seconds)
H:M	00 h 01 m to 99 h 59 m (in hours and minutes)

Monitor Enabled or Disabled

A	Operating parameters can be monitored and settings changed.
D	Operating parameters cannot be monitored nor settings changed.

### 3-6-3 Parameter Monitor Screen Display

#### All Timers Except Twin Timers

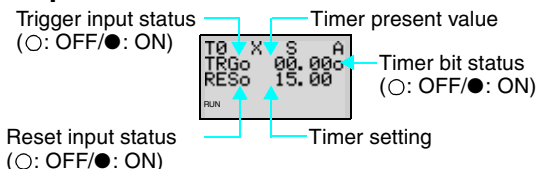

#### Twin Timers

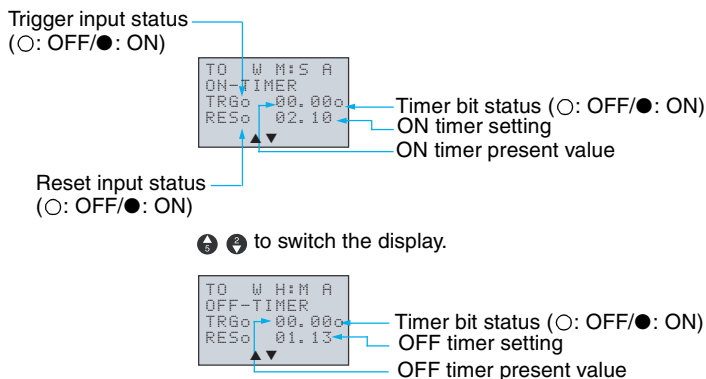

### 3-7 Using Counters (C) and the 8-Digit Counter (F)

Up to 16 counters and one 8-digit counter can be used in incremental or decremental mode. The present value for counters and the status of counter bits (ON/OFF) are held even when the operating mode is changed or there is a power interruption.

#### Operation

Counter bits turn ON when the count value (present value) exceeds the setting (present value  $\geq$  set value). The count returns to 0 and the bits turn OFF when the reset input turns ON. Count inputs are not accepted while the reset input is ON.

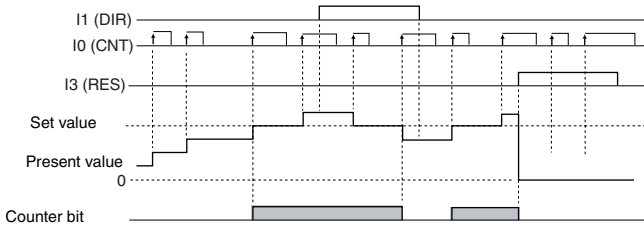

#### 3-7-1 Settings in the Ladder Program Edit Screen

Outputs for the counter input, counter direction, and counter reset are written in the Ladder Program Edit Screen. Counter input conditions can also be written. Settings are made in the Parameter Settings Screen.

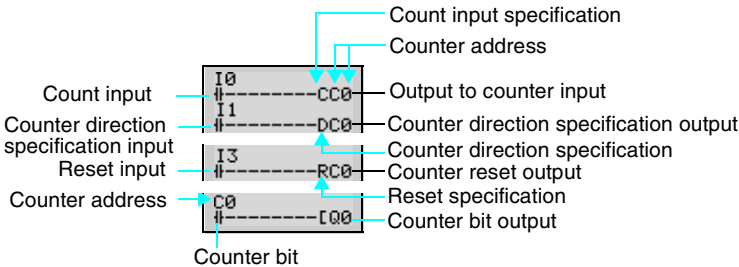

Counter address	Counter C0 to Cf (16 points)	
	8-Digit Counter F0 (1 point)	
Counter input	C (CNT)	Increments (or decrements) each time the count input turns ON.
Counter direction specification input	D (DIR)	Switches between incremental and decremental counting. OFF: Incremental ON: Decremental

Reset input	R (RES)	When the reset input turns ON, the present value returns to 0 and the counter bit turns OFF. Count inputs are not accepted while the reset input is ON.
Count input	Turns ON when the counter has counted out (PV ≥ SV)	

### 3-7-2 Settings in the Parameter Settings Screen

#### Counters (C)

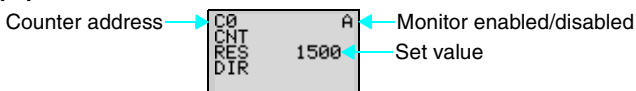

Set value	0001 to 9999 (4 decimal digits) times	
Monitor enabled/disabled	A	Operating parameters can be monitored and settings changed.
	D	Operating parameters cannot be monitored or settings changed.

The speed of the counter depends on whether a filter is used. Refer to page 104.

#### 8-Digit Counter (F)

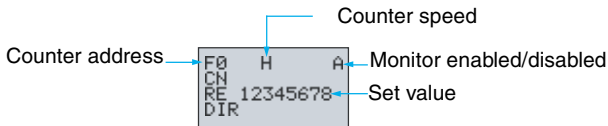

Set value	00000001 to 99999999 (4 decimal digits) times	
Counter speed	H	High speed (150 Hz, see note.) (10 for CPU Units with DC power supplies only)
	L	Low speed (Depends on whether a filter is used. Refer to page 104.)
Monitor enabled/disabled	A	Operating parameters can be monitored and settings changed.
	D	Operating parameters cannot be monitored or settings changed.

#### Note Counting Speed

The maximum counting speed of the 8-digit counter is 150 Hz regardless of whether an input filter is used. The maximum ladder program capacity, however, may be less than 150 Hz. Calculate the cycle time (refer to page 130) and confirm the maximum

counting speed using the following formula. The calculation serves as a guide only, so allow a suitable margin in the actual machine.

Maximum counting speed:  $1,000,000 / (\text{cycle time in } \mu\text{s} \times 2.2) \text{ Hz}$

Note Even if the calculated maximum counting speed exceeds 150 Hz using this formula, the maximum counting speed will be 150 Hz.

### 3-7-3 Parameter Monitor Screen Display

#### Counters (C)

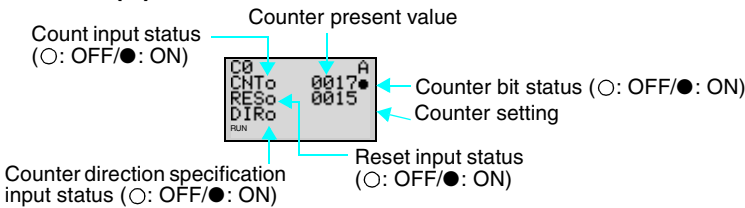

#### 8-Digit Counter (F)

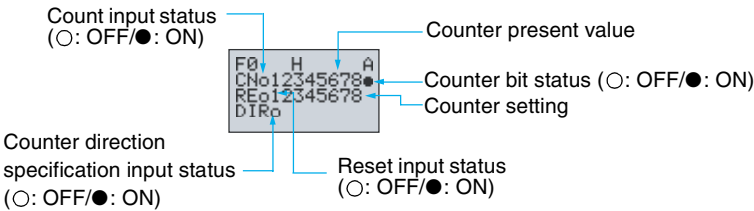

- Note**
- To reset the counter present value and counter bit status (ON/OFF) when at power interruptions or when the operating mode is changed, create a counter reset circuit when you first execute the program. An example is shown below.

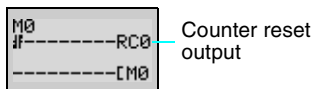

- If the counter input and counter direction are input simultaneously, place the output for the counter direction before the output for the counter input in the program.

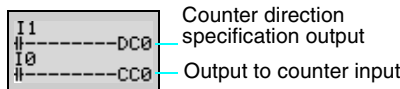



### 3-8 Using Weekly Timers (@)

Any of the following three operations, which vary in the day of week, time, and output time settings, can be selected for weekly timers.

#### Weekly Timer Operation (Standard LCD-type, Economy-type, and Communications-type CPU Units)

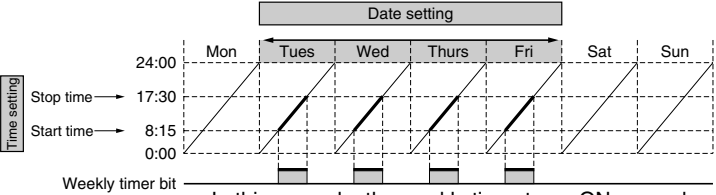
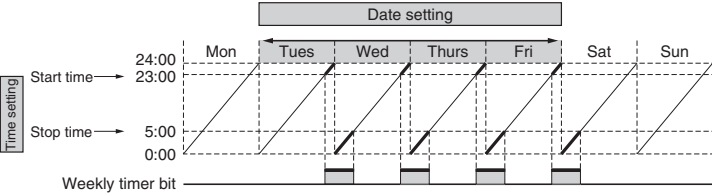
Weekly timer operation	Operation
Normal operation	<p>Typical Timer Operation</p>  <p>In this example, the weekly timer turns ON every day from Tuesday to Friday between 8:15 and 17:30.</p>
	<p>Timer Operation Extending Past Midnight</p>  <p>In this example, the weekly timer turns ON every day from Tuesday to Friday between 23:00 and 5:00.</p>

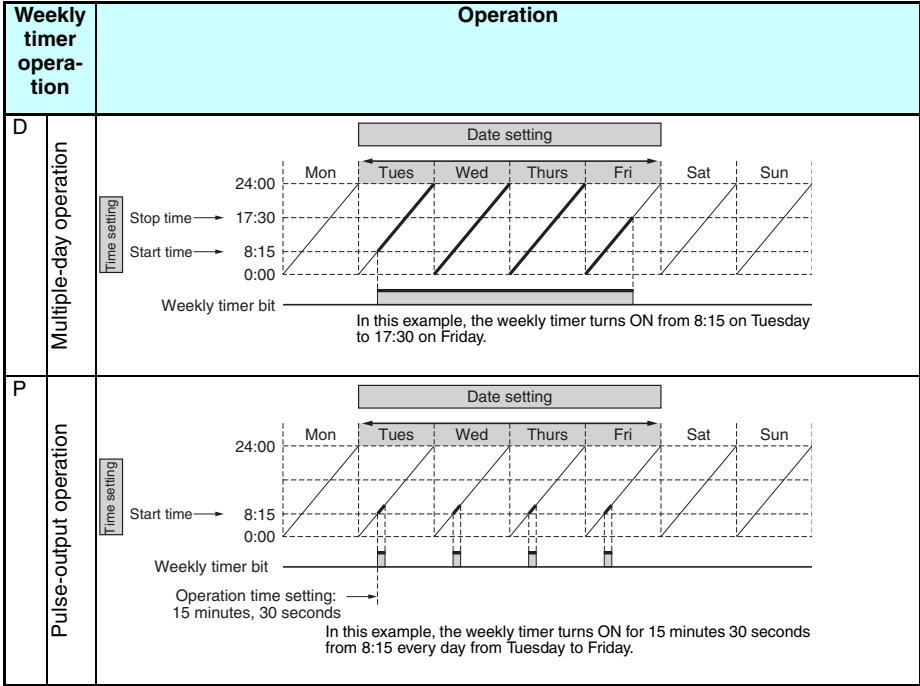

### 3-8-1 Settings in the Ladder Program Edit Screen

Weekly timer inputs are written in the Ladder Program Edit Screen. Settings are made in the Parameter Settings Screen.

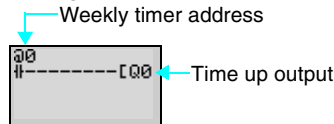

Weekly timer addresses	@0 to @f (16 timers)
------------------------	----------------------

### 3-8-2 Settings in the Parameter Settings Screen

#### Normal Operation (N)

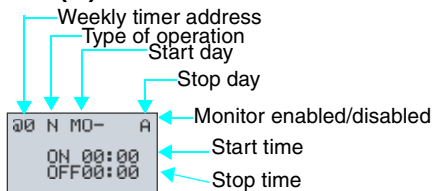

**Note** When the flashing cursor is on the start day, press the **Right** Button and then the **Up/Down** Buttons to set the stop day. If the stop day is not set, the timer will operate according to the set time only.

Type of operation	N	Normal
	D	Between days
	P	Pulse
Day	Start day	Sun/Mon/Tues/Wed/Thurs/Fri/Sat
	Stop day	Sun/Mon/Tues/Wed/Thurs/Fri/Sat/None
Time	Start time	00:00 to 23:59
	Stop time	00:00 to 23:59
Operating time		00:01 to 99:59 (mm:ss)
Monitor enabled/disabled	A	Operating parameters can be monitored and settings changed.
	D	Operating parameters cannot be monitored or settings changed.

#### Operation between Days (D)

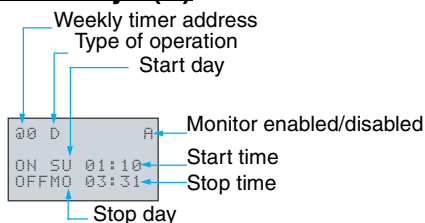

**Pulse Operation (P)**

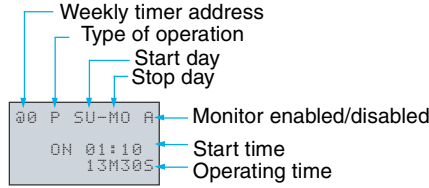

**Relationship between Start and Stop Days and Times**

Setting and operation		Setting example	Operation
Start and stop day	When start day is before stop day	MO - FR	Operates Monday to Friday every week.
	When start day is after stop day	FR - MO	Operates every Friday through to the following Monday.
	When start and stop days are the same	SU - SU	Normal and pulse operation: Operates regardless of the day of the week. Multiple-day operation: Operates every Sunday only (See note.)
	When stop day not set	SU -	Normal and pulse operation: Operates every Sunday only. Multiple-day operation: Cannot be set.
Start and stop time (normal operation)	When start time is before stop time	ON: 08:00 OFF: 17:00	Operates 8:00 to 17:00 every day.
	When start time is after stop time	ON: 21:00 OFF: 06:00	Operates 21:00 to 6:00 the next day.
	When start and stop times are the same	ON: 13:00 OFF: 13:00	Operates regardless of the time.

**Note** The multiple-day operation shown here is for when the start and stop days are the same (SU-SU).

1. Start time is before stop time (ON: 08:00/OFF: 17:00): Operates from 08:00 Sunday until 17:00 Sunday.
2. Start time is after stop time (ON: 21:00/OFF: 06:00): Operates from 21:00 Sunday until 06:00 the following Sunday.
3. Start and stop times are the same: Operates regardless of the time.

### 3-8-3 Parameter Monitor Screen Display

#### Normal Operation (N)

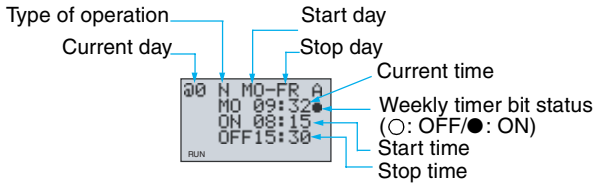

#### Operation between Days (D)

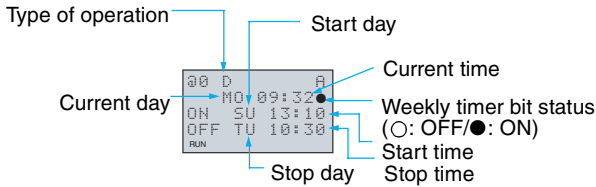

#### Pulse Operation (P)

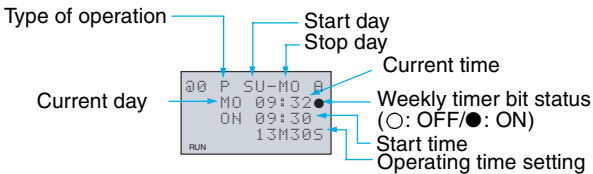

### 3-9 Using Calendar Timers (\*)

Calendar timers turn ON between specified dates.

#### Calendar Timer Operation (Standard LCD-type, Economy-type, and Communications-type CPU Units)

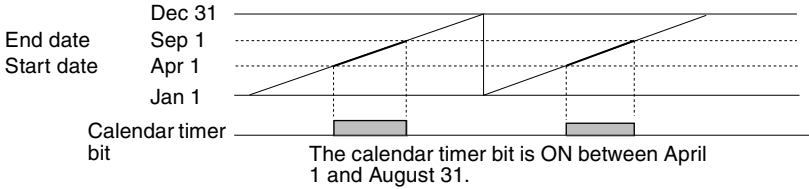

#### 3-9-1 Settings in the Ladder Program Edit Screen

Calendar timer inputs are written in the Ladder Program Edit Screen. Settings are made in the Parameter Settings Screen.

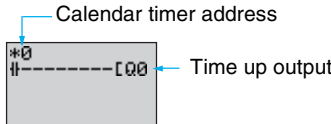

Calendar timer address	*0 to *f (16 timers)
------------------------	----------------------

#### 3-9-2 Settings in the Parameter Settings Screen

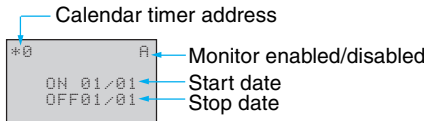

Start date	Jan 1 to Dec 31	
Stop date (See note.)	Jan 1 to Dec 31	
Monitor enabled/ disabled	A	Operating parameters can be monitored and settings changed.
	D	Operating parameters cannot be monitored or settings changed.

**Note** To stop operation on August 31, set the stop date to the following day (September 1).

**Relationship between Start and Stop Dates**

Setting and operation	Setting example	Operation
Start and stop date settings and operation	When start date is before stop date	ON: 04/01 OFF: 09/01 Operates between 1 April and 31 August. (See note.)
	When start date is after stop date	ON: 12/26 OFF: 01/07 Operates between 26 December and 6 January the following year.
	When start and stop dates are the same.	ON: 07/26 OFF: 07/26 Operates regardless of the date.

**Note** To stop operation on August 31, set the stop date to the following day (September 1).

**3-9-3 Parameter Monitor Screen Display**

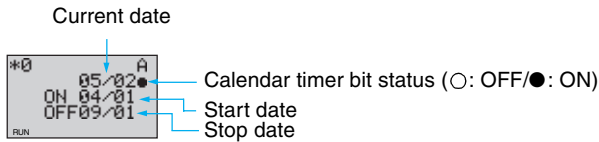

**3-10 Analog Inputs (Analog Comparators (A))**

Two analog voltage inputs between 0 and 10 V can be incorporated into the CPU Units with a DC power supply. I4 and I5 for CPU Units with 10 I/O points and Ia and Ib for CPU Units with 20 I/O points can be used as analog voltage inputs.

The analog input signal is converted to BCD (00.0 to 10.0). The results can be used with one of the comparators A0 to A3, and the 4 comparison outputs can be used as input conditions in the program.

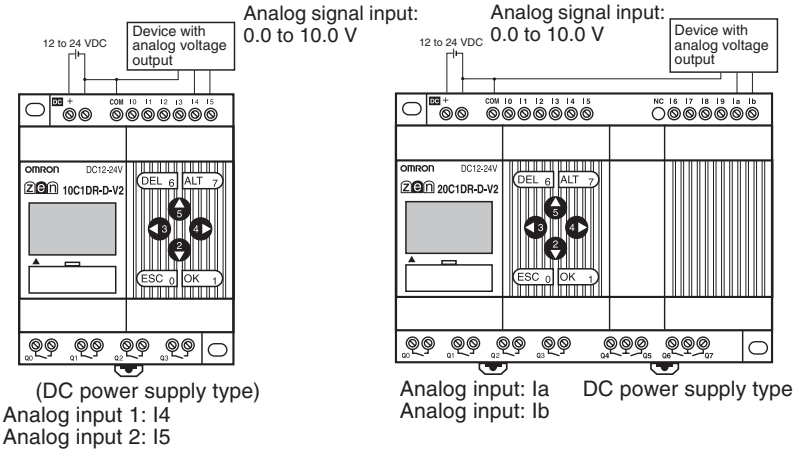

**Note** Connect the negative side to COM for analog inputs. The analog input circuit may be destroyed if the positive side is connected to COM.

**Operation**

- Example 1  
(When comparison shows analog input 1  $\geq$  5.2 V)

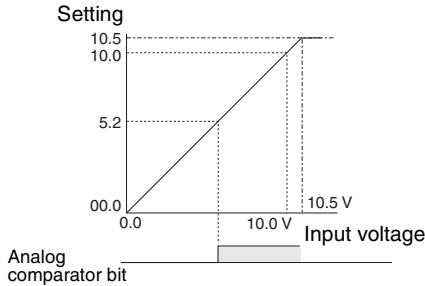

The analog comparator bit turns ON when the analog input voltage reaches is 5.2 V or higher.

- Example 2  
(When comparison shows analog input 1 is  $\leq$  analog input 2)

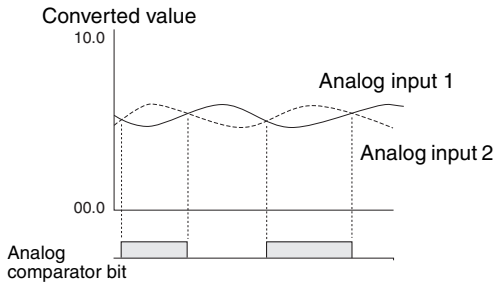

The analog comparator bit turns ON when the analog input 2 voltage is higher than the analog input 1 voltage.

**|| Precautions for Correct Use ||**

- Do not make negative signal inputs to analog inputs. If negative signals are made, the internal elements may be damaged.
- A delay of up to 26 times the cycle time may occur from the time an analog voltage equivalent to the SV is input until the analog comparator bit turns ON. Refer to *Appendix B Ladder Program Execution on page 129* and be sure that this delay will not create any problems.



### 3-10-1 Settings in the Ladder Program Edit Screen

The analog comparator input is written in the Ladder Program Edit Screen. Settings are made in the Parameter Settings Screen.

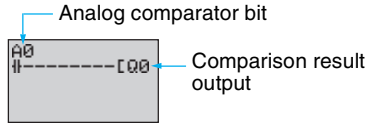

Analog comparator address	A0 to A3 (4 comparators)
---------------------------	--------------------------

### 3-10-2 Settings in the Parameter Settings Screen

- Comparing Analog Inputs and Constants  
(When I4 (Ia) ≥ constant)

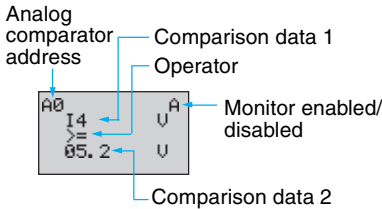

- Comparing Analog Inputs  
(When I4 (Ia) ≤ I5 (Ib))

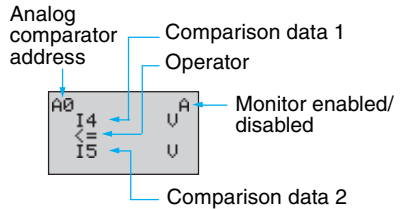

Refer to page 25 for parameter setting methods.

Comparison data 1 determines the comparison pattern. When comparing to a constant, the constant is set for comparison data 2 next. The operator is specified last.

Analog comparator address	A0 to A3 (4 comparators)	
Comparison data	1	I4 (Ia): Analog input 1 I5 (Ib): Analog input 2
	2	I5 (Ib): Analog input 2 Constant: 00.0 to 10.5
Operator	Comparison Patterns	
	<ul style="list-style-type: none"> <li>Size comparison between I4 (Ia) and I5 (Ib).</li> <li>Size comparison between I4 (Ia) and constant.</li> <li>Size comparison between I5 (Ib) and constant.</li> </ul>	
Monitor enabled/disabled	>=: Analog comparator bit turns ON when comparison data 1 ≥ comparison data 2.	
	<=: Analog comparator bit turns ON when comparison data 1 ≤ comparison data 2.	
Monitor enabled/disabled	A	Operating parameters can be monitored and settings changed.
	D	Operating parameters cannot be monitored or settings changed.

**Note** For CPU Units with 20 I/O points, Ia is analog input 1 and Ib is analog input 2.

### 3-10-3 Parameter Monitor Screen Display

- Comparing Analog Inputs and Constants  
(When I4 (Ia)  $\geq$  constant)

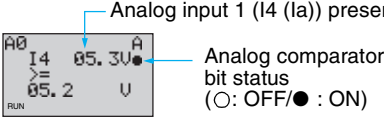

- Comparing Analog Inputs  
(When I4 (Ia)  $\leq$  I5 (Ib))

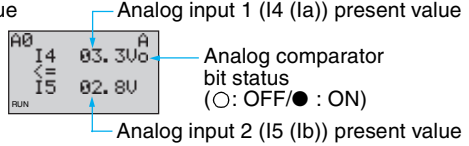

## 3-11 Comparing Timer/Counter Present Values Using Comparators (P)

Timer (T), holding timer (#), and counter (C) present values can be compared. The present values of the same type of timer or counter can be compared, or they can be compared to constants.

### Operation

- Example 1  
(When comparison setting is holding timer #0  $\geq$  12 min 34 s)

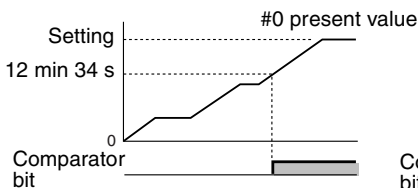

- Example 2  
(When comparison setting is counter 1 (C1)  $\leq$  counter 2 (C2))

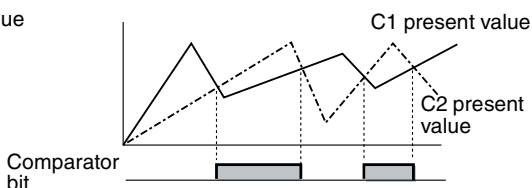

### 3-11-1 Settings in the Ladder Program Edit Screen

Comparator inputs are written in the Ladder Program Edit Screen. Settings are made in the Parameter Settings Screen.

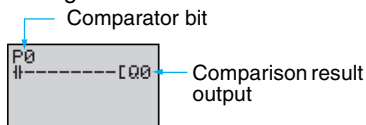

Comparator addresses	P0 to Pf (16 points)
----------------------	----------------------

### 3-11-2 Settings in the Parameter Settings Screen

- Comparing Holding Timers and Constants  
(When Holding Timer #0 ≥ 12 min 34 s)
- Comparing Counters  
(When counter 1 (C1) ≤ counter 2 (C2))

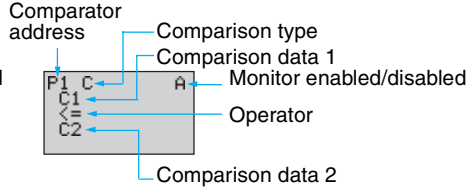
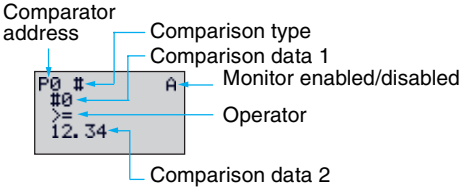

**Note** Press the **ALT** Button to switch between comparison data 2 timer/counter address and constants.

Comparison type		T: Timer #: Holding timer C: Counter	
Comparison data	1	T: T0 to Tf Timers 0 to f #: #0 to #7 Holding timers 0 to 7 C: C0 to Cf Counters 0 to f	* Size comparison between T and T or T and constant. * Size comparison between # and # or # and constant. * Size comparison between C and C or C and constant.
	2	T: T0 to Tf Timers 0 to f #: #0 to #7 Holding timers 0 to 7 C: C0 to Cf Counters 0 to f Constant: 00.00 to 99.99 when comparison type is T/# 0000 to 9999 when comparison type is C	
Operator		>=: Timer/counter comparator bit turns ON when comparison data 1 ≥ comparison data 2. <=: Timer/counter comparator bit turns ON when comparison data 1 ≤ comparison data 2.	
Monitor enabled/disabled	A	Operating parameters can be monitored and settings changed.	
	D	Operating parameters cannot be monitored or settings changed.	

### 3-11-3 Parameter Monitor Screen Display

- Comparing Holding Timers and Constants  
(When Holding Timer #0  $\geq$  12 min 34 s)
- Comparing Counters  
(When counter 1 (C1)  $\leq$  counter 2 (C2))

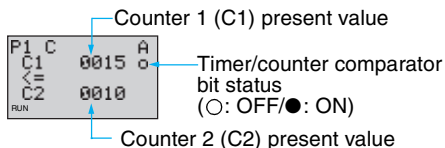
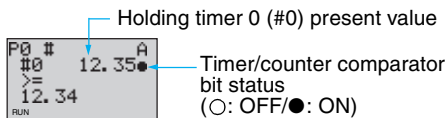

**Note**

The time unit is determined as follows when timers or holding timers have been specified under comparison type:

- a) When a constant has been set to as comparison data 2, the time unit is automatically aligned with the unit for comparison data 1 timers or holding timers.
- b) The time units are automatically aligned when the units are different for comparison data 1 and 2 timers.

## 3-12 Comparing the 8-Digit Counter (F) Present Value Using 8-Digit Comparators (G)

The present value of the 8-digit counter (F) can be compared to a constant.

### Operation

**Example for 8-Digit Counter  $\geq 12000000$**

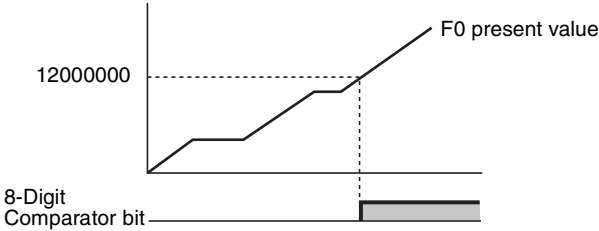

### 3-12-1 Settings in the Ladder Program Edit Screen

Comparator inputs are written in the Ladder Program Edit Screen. Settings are made in the Parameter Settings Screen.

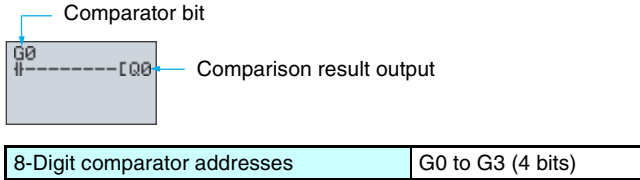

### 3-12-2 Settings in the Parameter Settings Screen

- **Example for 8-Digit Counter  $\geq 12000000$**

8-Digit comparator address

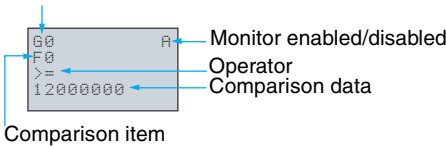

Refer to page 25 for parameter setting methods.

Comparison item	8-Digit counter (F0)	
Comparison data	Constant: 00000000 to 99999999	
Operator	>=: Comparator bit turns ON when 8-digit counter present value ≥ Comparison data.	
	<=: Comparator bit turns ON when 8-digit counter present value ≤ Comparison data.	
Monitor enabled/ disabled	A	Operating parameters can be monitored.
	D	Operating parameters cannot be monitored.

### 3-12-3 Parameter Monitor Screen Display

- Example for 8-Digit Counter ≥ 12000000

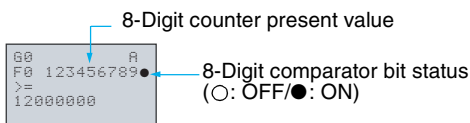

### 3-13 Displaying Messages (Display Bits (D))

A user-specified message, the time the message is displayed, a timer/counter present value, or an analog conversion value can be displayed on the LCD screen. If multiple display functions are used, multiple data can be displayed on the same screen.

#### Display Bits Operation (Standard LCD-type, Economy-type, and Communications-type CPU Units)

- Operation Example 1
- Operation Example 2

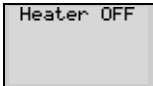

Monitors the system operation status.

Settings Details

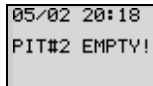
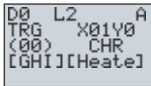

Displays the date and time that the system error occurred.

Settings Details

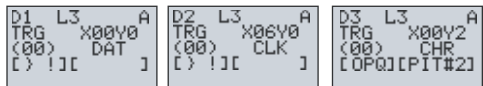

**Note**

1. The ZEN ladder program is executed in order of ascending line numbers. If more than one item is displayed on the same line, the display function that was executed last will be shown on the display and previous ones will be deleted.
2. The display clear function will erase all displays from the specified digit on (i.e., the display will be blank). If the display clear function is executed for the same line after another display function, the characters will still be erased from the specified digit on.

#### 3-13-1 Settings in the Ladder Program Edit Screen

The display functions are written in the Ladder Program Edit Screen. Settings are made in the Parameter Settings Screen.

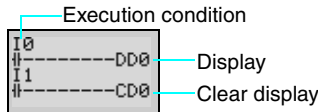

Display address	D0 to Df (16 points)
-----------------	----------------------



### 3-13-2 Settings in the Parameter Settings Screen

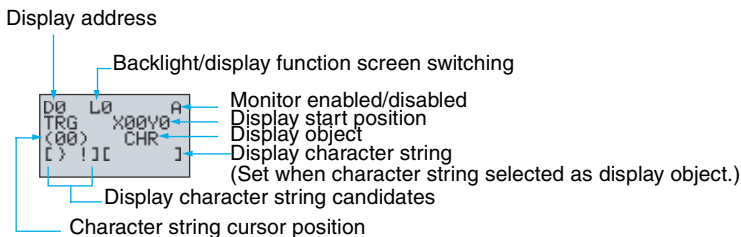

Backlight/display function screen switching	L0	No backlight; No switching to display function screen (See note 1.)
	L1	Backlight; No switching to display function screen (See note 1.)
	L2	No backlight; Switching to display function screen (See note 2.)
	L3	Backlight; Switching to display function screen (See note 2.)
Display start position	X (digit): 00 to 11 Y (line): 0 to 3 	
Display object	CHR	Characters (12 max.: Alphanumeric characters and symbols)
	DAT	Month/day (5 digits: □□/□□)
	DAT1	Day/month (5 digits: □□/□□)
	CLK	Hour/minutes (5 digits: □□:□□)
	14, 15 (1a, 1b)	Analog conversion (4 digits: □□.□)
	T0 to Tf	Timer present value (5 digits: □□.□□)
	#0 to #7	Holding timer present value (5 digits: □□.□□)
	C0 to Cf	Counter present value (4 digits: □□□□)
Monitor enabled/disabled	F0	8-Digit counter present value (8 digits: □□□□□□□□)
	A	Operating parameters can be monitored.
	D	Operating parameters cannot be monitored.

- Note**
- When L0 or L1 are selected to disable the display function screen, the display function screen will not be displayed automatically. Use operation buttons to move to the display function screen.
  - When L2 or L3 are selected (switching to display function screen), the ZEN switches to the display function screen if the display function is enabled and the specified data is displayed. The Main Screen will no longer be displayed. To display the Main Screen, change the CPU Unit to STOP mode.

### Settings when Character (CHR) Selected

Move the highlighted cursor to the display character string column.

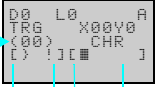

Display character string columns (12 characters max.)  
 Candidates for display character string  
 Character string cursor position

OK



Position within character string  
 Character to be selected  
 Characters before and after character to be selected

Flash simultaneously while settings are being made

⬆ ( ⬇ )

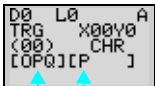

Use the **Up/Down** Buttons to scroll through the candidate characters.  
  
 Alternates display of the candidate character and the position mark.  
  
 Candidate is highlighted and flashing.

⬆



Use the **Right** Button to move the character string position to the right. Use the **Left** Button to move the character string to the left.

⬆ ( ⬇ )

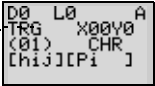

OK



### Table of Display Characters

	!	"	#	\$	%	&	'	(	)	*	+	,	-	.	/
0	1	2	3	4	5	6	7	8	9	:	:	<	=	>	?
a	b	c	d	e	f	g	h	i	j	k	l	m	n	o	
p	q	r	s	t	u	v	w	x	y	z	[	]	{	}	~
`	a	b	c	d	e	f	g	h	i	j	k	l	m	n	o
P	a	r	e	t	w	v	w	x	y	z	<		>		

### 3-14 Using Button Input Bits (B)

The operation buttons are assigned operations of input bits. They are useful when checking program operations or forcefully resetting timer/counter present values. LED-type CPU Units do not have button switches.

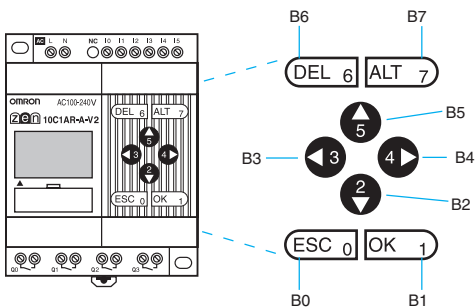

Button switch address	Operation button
B0	ESC
B1	OK
B2	Down
B3	Left
B4	Right
B5	Up
B6	DEL
B7	ALT

## Using Button Input Bits

- The buttons can also be used as “hidden keys” for software resets of counters or holding bit present values.

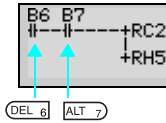

Press the **DEL+ALT** Buttons simultaneously during operation to reset the counter C2 present value to 0 and the holding bit H5 to OFF.

### Note

- When a button is pressed, e.g., to make a menu selection, the operation defined for the button in the ladder program as a button switch (B) will also be executed. This may cause unexpected results, such as an output turning ON/OFF. Be sure to test the program completely.
- The **ESC+OK** Buttons are used to switch menu displays. We recommend not using these as button switches (B).

# SECTION 4

## Special Functions

This section describes how to protect ladder programs, stabilize inputs, make LCD screen adjustments, and make summer time settings.

4-1	Protecting Programs . . . . .	102
4-1-1	Setting a Password . . . . .	103
4-1-2	Deleting Registered Passwords . . . . .	103
4-2	Stabilizing Input Operations . . . . .	104
4-3	Changing Backlight Automatic Cutout Time . . . . .	106
4-4	Setting Daylight Saving Time (DST). . . . .	107
4-5	Reading System Information . . . . .	108

## 4-1 Protecting Programs

The ZEN has a password function to prevent incorrect manipulation of ladder programs or settings data by other operators.

### || Precautions for Correct Use ||

Always record your password for future reference when using the password function. You will no longer be able to operate the ZEN if you forget your password.

If you forget the password, clear the ZEN memory from the ZEN Support Software. The ZEN will be initialized, making it necessary to enter the ladder program and settings again.

- The password setting range is 0000 to 9999 (4 decimal digits).
- You will no longer be able to perform the following operations if the password is not input correctly.

Edit ladder programs

Clearing programs

Monitor ladder programs

Change or delete the password

Set the input filter

RS-485 communications settings

- When any of these functions is selected from the menu, the Password Input Screen will be displayed. If the password is input correctly, the display will move to the next screen for the selected function. However, if the password is input incorrectly, the next screen will not be displayed.

### 4-1-1 Setting a Password

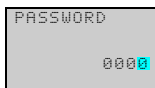
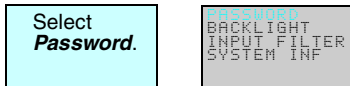
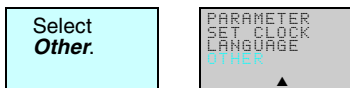

Press the **OK** Button to change to a flashing cursor and enable a password to be set.

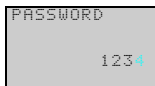

Set the password.

Use the **Left** and **Right** Buttons to move to the digit to be changed.

Use the **Up/Down** Buttons to input a numeral between 0 and 9.

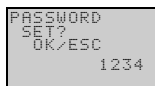

Press the **OK** Button. A confirmation message will be displayed.

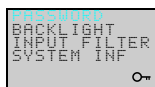

The **OK** icon will appear at the bottom right of the screen when a password has been registered.

**Note** The display will automatically change to the Waiting for Password Input Screen when making settings that require a password to be input. Use the same method as outlined above to input the registered password.

### 4-1-2 Deleting Registered Passwords

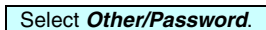

Press the **OK** Button to change to a flashing cursor and to enable password setting.

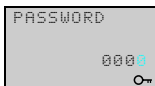

Input the registered password.

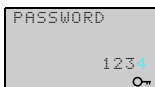

Use the **Left** and **Right** Buttons to move to the digit to be changed.

Use the **Up/Down** Buttons to input a numeral between 0 and 9.

OK 1

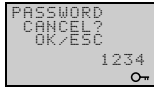



Press the **OK** Button to display a message asking whether or not to delete the set password.

If the input password does not match the registered password, the display will return to the original screen.

If the password was correct, press the **OK** Button to delete the password.

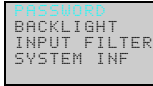
OK 1



The  icon will disappear when the password is deleted.

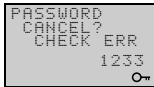

If the input password does not match the registered password, a CHECK ERR message will be displayed. Re-enter the password correctly.

## 4-2 Stabilizing Input Operations

If external input contacts chatter, ZEN operation may become unstable. Set an input filter to stabilize operation. Input filters can be set separately for the CPU Unit and each Expansion I/O Unit.

### Operation (Example: DC Input Circuits)

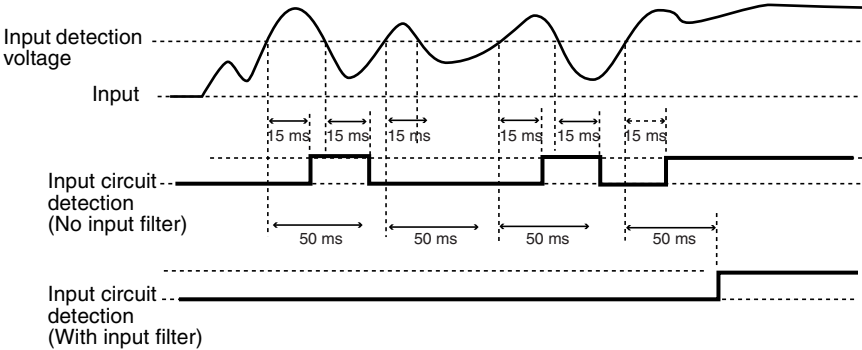



Select  
**Other/Input  
filter.**

PASSWORD  
BACKLIGHT  
INPUT FILTER  
SYSTEM INF  
▼



EXP 1  
EXP 2  
EXP 3

CPU Unit input

Expansion I/O Unit input  
(Displayed only when Expansion  
Units are connected.)

Press the **OK** Button to display the Input Filter Settings Menu.

Use the **Up** and **Down** Buttons to select from the menu the Unit for which the input filter is to be set.



INPUT FILTER  
INNER  
OFF

Press the **OK** Button to display the present setting.

Press the **OK** Button again to change to a flashing cursor and enable input filter settings to be made.



INPUT FILTER  
INNER  
ON

Use the **Up/Down** Buttons to switch between ON and OFF.



Press the **OK** Button to confirm the setting.

Press the **OK** Button again to complete the setting.

**Note** 1. The filter timers outlined in the following table are set for each input type when the input filter function is set.

Input specifications		Input filter not used	Input filter used
AC input	100 VAC	50 ms	70 ms
	240 VAC	100 ms	120 ms
DC input		15 ms	50 ms

2. The input filter settings are read when the ZEN starts operation.

### 4-3 Changing Backlight Automatic Cutout Time

The LCD backlight automatically turns ON when button operations are performed. It then turns OFF automatically 2 minutes after button operations stop. The default backlight cutout setting of 2 minutes can be changed to 10 or 30 minutes or the backlight can be set to remain ON continuously.

Button operation	Operation starts	.....	Operation stops	
Display function (when L1 or L3 is set)	OFF → ON - — DDO	.....	ON → OFF - — DDO	Cutout time ←————→
Backlight status	ON	Remains ON.		Remains ON.
				Turns OFF.

Select **Other/Backlight.**



Press the **OK** Button to display the current backlight cutout setting.

Press the **OK** Button again to change to a flashing cursor and enable backlight cutout time settings to be made.



Use the **Up** and **Down** Buttons to set the cutout time.

- 2 ON (Continuously ON)
- ↓ 30 min
- ↑ 10 min
- 5 2 min



Press the **OK** Button to confirm the setting.

Press the **OK** Button again to complete the setting.

**Note** The backlight cutout time is used not only to determine if and when the backlight turns OFF after button operations have stopped. If backlight has been specified to turn ON with the display function, the same setting is used to determine if and when the backlight turns OFF once the execution of the display function has been completed.

## 4-4 Setting Daylight Saving Time (DST)

Set the Daylight Saving Time (DST) function when using the ZEN in countries that use Daylight Saving Time (DST).

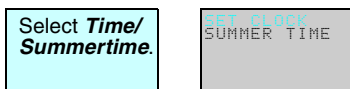

OK

OK



Press the **OK** Button to display the current settings.

Press the **OK** Button again to change to a flashing cursor and enable Daylight Saving Time (DST) settings to be made.



Use the **Up** and **Down** Buttons to make the setting.

- 2 NZ Type (for Daylight Saving Time (DST) in New Zealand)
- ↓ AU Type (for Daylight Saving Time (DST) in Australia)
- ↑ US Type (for Daylight Saving Time (DST) in USA)
- ↑ EU Type (for Daylight Saving Time (DST) in Europe)
- 5 Manual (for manual settings)
- Cancel (for no Daylight Saving Time (DST))

OK

OK

Press the **OK** Button to confirm the setting.  
Press the **OK** Button again to complete the setting.

Cancel	Daylight Saving Time (DST) settings are not made. Any Daylight Saving Time (DST) settings that have been made will be deleted.	
Manual	Moves the clock forward 1 hour.	
EU Type	Daylight Saving Time (DST) period: 2:00 a.m last Sunday in March to 3:00 a.m. last Sunday in October	Once the start time (2:00 a.m.) has been reached, the clock is moved forward 1 hour to 3:00 a.m. When the stop time (3:00 a.m.) has been reached, the clock is moved backwards 1 hour to 2:00 a.m.
AU Type	Daylight Saving Time (DST) period: 2:00 a.m first Sunday in October to 3:00 a.m. first Sunday in April	
NZ Type	Daylight Saving Time (DST) period: 2:00 a.m last Sunday in September to 3:00 a.m. first Sunday in April	
US Type	Daylight Saving Time (DST) period: 2:00 a.m second Sunday in March to 2:00 a.m. first Sunday in November	Once the start time (2:00 a.m.) has been reached, the clock is moved forward 1 hour to 3:00 a.m. When the stop time (2:00 a.m.) has been reached, the clock is moved backwards 1 hour to 1:00 a.m.

**Note** When Daylight Saving Time (DST) has been set, an “S” will appear at the top right of the Time Settings Screen during the Daylight Saving Time (DST) period.



"S" displayed during the Daylight Saving Time (DST) period.

## 4-5 Reading System Information

The software version of the CPU Unit, the number of CPU Unit and Expansion I/O Unit I/O points, and other information can be read.

Select **Other/ System information.**



OK →



- Software version (e.g., Ver 3.00)
- Date software created (e.g., 2006 February 1)
- No. of CPU Unit I/O points (e.g., 6 inputs, 4 outputs)
- No. of Expansion Unit 1 I/O points (e.g., 4 inputs, 4 outputs)
- No. of Expansion Unit 2 I/O points (e.g., 4 inputs, 4 outputs)
- No. of Expansion Unit 3 I/O points (e.g., 4 inputs, 4 outputs)
- (For function expansion)
- Availability of LCD screen (e.g., Yes)
- Availability of calendar and time function (e.g., Yes)
- Availability of analog input (e.g., No)

# SECTION 5

## Optional Products

This section describes how to mount Battery Units, use Memory Cassettes, and how to connect the ZEN Support Software.

5-1	Mounting Battery Units .....	110
5-2	Using Memory Cassettes .....	111
5-3	Connecting the ZEN Support Software .....	114

## 5-1 Mounting Battery Units

Ladder programs and all settings are saved to the CPU Unit EEPROM but calendar, clock, and holding timer bits and holding timer/counter present values are held by the capacitor. Therefore, if the power supply is interrupted for 2 days or more (at 25°C), this data will be reset. Mount a Battery Set (optional) for systems where the power supply may be interrupted for long periods.

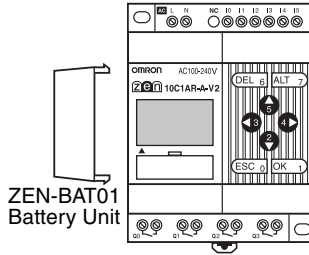

### Mounting Method

1,2,3...

1. Tilt the Battery Unit to the side and insert the claw at the bottom of the Battery Unit into the mounting hole on the left side of the CPU Unit.

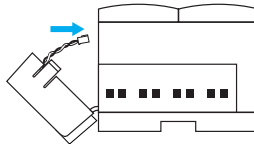

2. Connect the Battery Unit cord to the CPU Unit connector.

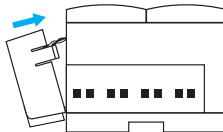

3. Push the claw at the top of the Battery Unit into the CPU Unit.

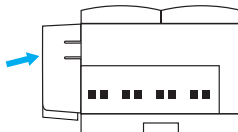

**⚠ WARNING**

A lithium battery is used in the Battery Unit. Do not short the battery terminals or charge, disassemble, deform under pressure, or incinerate the battery. Doing any of these may occasionally result in serious injury due to ignition or rupture of the battery.

Never use any battery that has been dropped on the floor or otherwise subjected to excessive shock.

**|| Precautions for Correct Use ||**

- Turn OFF the power supply to the CPU Unit before mounting the Battery Unit.
- Do not remove the label from the left side of the CPU Unit if a Batter Unit is not mounted.

**Note** The Battery Unit has a life of 10 years min.

## 5-2 Using Memory Cassettes

Optional Memory Cassettes can be used to save the ladder program and settings and to copy programs and settings to other CPU Units.

### Mounting Memory Cassettes

- 1,2,3...** 1. Remove the connector cover on the front of the ZEN.

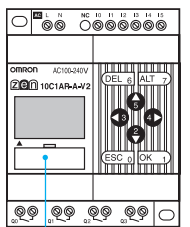

Connector cover

(Use a flat-blade screwdriver if the cover is difficult to remove.)

2. Mount the Memory Cassette.

ZEN-ME01  
Memory Cassette

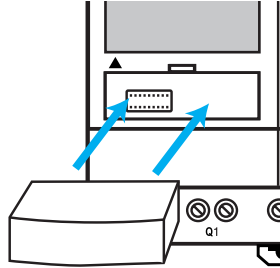

**|| Precautions for Correct Use ||**

Always turn OFF the power supply to the CPU Unit before removing or mounting Memory Cassettes.

**Transferring Programs**

Select  
**Program** in  
STOP mode.

```
PROGRAM
RUN
PARAMETER
SET CLOCK
```



```
EDIT PROG
DELETE PROG
CASSETTE
```

Select **Cassette**.



```
LOAD (MC->CPU)
ERASE
```

The Operation Menu for Memory Cassettes will be displayed.

Use the **Up/Down** Buttons to move the flashing cursor and press the **OK** Button to select an operation.

Menu	Operation	LCD-type CPU Units	LED-type CPU Units
Save (CPU Unit to MC)	Saves CPU Unit programs to the Memory Cassette. Existing programs on the Memory Cassette will be overwritten.	Supported	Not supported
Load (MC to CPU Unit)	Transfers programs from the Memory Cassette to the CPU Unit.	Supported	Automatically transferred at power-ON.
Erase	Initializes the Memory Cassette (i.e. deletes programs).	Supported	Not supported

**Note**

1. The transferable program includes the ladder programs, parameters, and all settings data. The present values for the timers, holding timers, counters, and holding bits cannot be transferred.



2. Only error-free programs can be transferred. The program will not be transferred if there is any illegal data in the program.
3. The Memory Cassette can be written to up to 100,000 times.

### **Mounting Memory Cassettes to LED-type CPU Units**

When a Memory Cassette with an error-free program is mounted to an LED-type CPU Unit, the program on the Memory Cassette is automatically transferred to the CPU Unit. The existing program in the CPU Unit will be overwritten.

The operating mode will switch to RUN mode and the program on the Memory Cassette will be executed. Always confirm safety before turning ON the power supply. (Refer to *Appendix C Operating Mode at Startup.*)

## 5-3 Connecting the ZEN Support Software

The ZEN Support Software can be used for programming and monitoring. Refer to the *ZEN-SOFT01-V4 ZEN Support Software Operation Manual* (Z184) for information on the functions and operation of the ZEN Support Software.

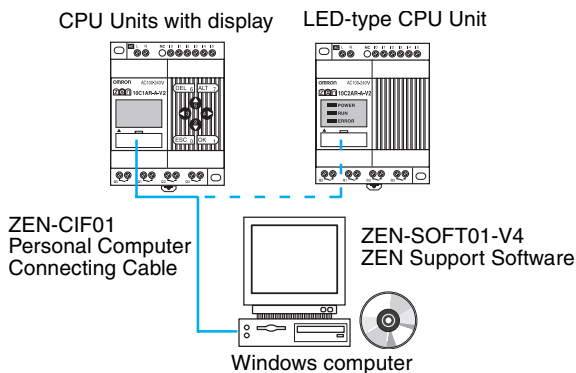

**Note** RS-485 communications and ZEN monitoring cannot be performed at the same time with CPU Units with communications. If a Personal Computer Connecting Cable is connected to the ZEN when the power supply is turned ON, a message will be displayed on the ZEN asking if it is okay to stop RS-485 communications.

### Computer Specifications

Item	Conditions
Operating system	Windows 98, 98SE, ME, 2000, XP, NT4.0 Service Pack 3, or Vista
CPU	Pentium 133 MHz or faster (Pentium 200 MHz or faster recommended)
Memory	64 Mbytes min.
HD capacity	40 Mbytes free disk space min.
CD-ROM drive	Required.
Communications	1 serial (COM) port
Keyboard and mouse	Required
Monitor	800 x 600 dots (SVGA) min.; 256 colors min.

**Note** When connecting to a computer that does not have a serial port, connect an RS-232C–USB Conversion Cable to the ZEN-CIF01 Computer Connecting Cable. An OMRON CS1W-CIF31 Conversion Cable can be used (cable length: 50 cm).

# SECTION 6

## Troubleshooting

This section lists the error messages and provides probable causes and countermeasures for troubleshooting.

6-1	Troubleshooting .....	116
6-2	Error Messages .....	116
6-3	Deleting Error Messages .....	118

## 6-1 Troubleshooting

Search for the cause of the error and take immediate countermeasures if ERR or any other error message appears on the LCD screen (for CPU Units with display) or the ERROR indicator is lit (on LED-type CPU Units).

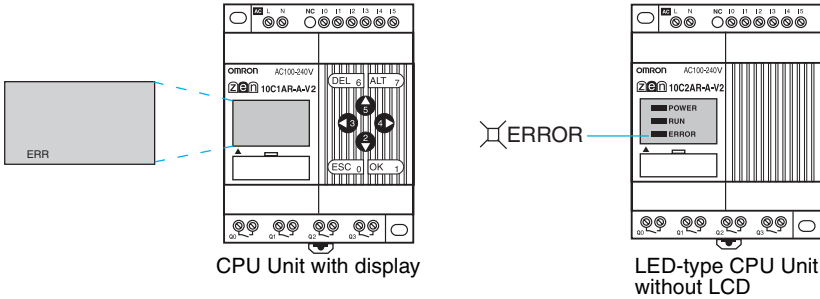

## 6-2 Error Messages

The following tables list the error messages that are displayed when an error occurs.

### Power ON but No Operation

Error message	Probable cause	Possible solution
MEMORY ERR	Program error.	The ladder program and parameter settings have been cleared. Write a program to the ZEN again.
I/O BUS ERR	Expansion I/O Unit connection error.	Turn OFF the power supply and check that the Expansion I/O Units are connected properly.
UNIT OVER	More than 3 Expansion I/O Units connected.	Turn OFF the power supply and reduce the number of Expansion I/O Units to 3 or less.
I/O VRFY ERR	Bit type that cannot be used with system configuration included in ladder program. (See note.)	Remove the illegal bit type from the program.

**Note** I/O Verification Error

Expansion I/O Unit I/O bits (X/Y): Bit not allocated in system configuration has been used.

Analog comparators (A): Used with AC power supply type.

Weekly timers (@)/Calendar timers (\*): Used with ZEN with LED displays.

Display function (D):

- For AC power supply types, analog-converted values (I4/I5 or Ia/Ib) are specified as the displayed items.
- For LED-type CPU Units, the date (DAT), day/month (DAT1), and time (CLK) are specified as the displayed items.

**Error at Power ON or During Operation**

<b>Error message</b>	<b>Probable cause</b>	<b>Possible solution</b>
I/O BUS ERR	Expansion I/O Unit connection error.	Turn OFF the power supply and check that the Expansion I/O Unit is connected properly.
MEMORY ERR	Program error.	Execute the All Clear operation and then re-write the program.
I2C ERR	Communications error between Memory and RTC.	Press any operation button and clear the error. Replace the CPU Unit if the error occurs frequently.

**Error During Program Transfer from Memory Cassette**

<b>Error message</b>	<b>Probable cause</b>	<b>Possible solution</b>
M/C ERR	Memory cassette program error.	Save the error-free program to the Memory Cassette again.

**Note** Use the ZEN Support Software to read error messages for LED-type CPU Units.

### 6-3 Deleting Error Messages

A flashing error message is displayed when an error occurs. Turn OFF the power supply and remove the cause of the error.

Press any operation button to delete the error message. Once the error has been removed the display will return to normal.

Error Message Display Screen

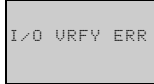

Press either the **ESC, OK, DEL, ALT, Left/Right**, or **Up/Down** Buttons. Any button can be pressed to delete the error message.

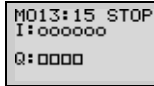

Press any button to return to normal display.

**Note** The error display will remain for internal errors that cannot be fixed, such as I/O Bus errors and I/O Unit Over errors.



↑ ERR will remain on the display.

# Appendix A

## Specifications

### Ratings

Item	Specifications	
	ZEN-□C□AR-A-V2/ZEN-8E1AR	ZEN-□C□D□-D-V2/ZEN-8E1D□
Power supply voltage	100 to 240 VAC, 50/60 Hz	12 to 24 VDC (ripple: 5% max.)
Rated power supply voltage	85 to 264 VAC, 47/63 Hz	10.8 to 28.8 VDC
Power consumption	<p>(1) CPU Units without Expansion I/O Units</p> <ul style="list-style-type: none"> <li>• ZEN-10C1AR-A-V2 /ZEN-10C2AR-A-V2 /ZEN-10C3AR-A-V2 100 V AC: 5 VA max. 240 V AC: 7 VA max.</li> <li>• ZEN-10C4AR-A-V2 100 V AC: 6 VA max. 240 V AC: 8 VA max.</li> <li>• ZEN-20C□AR-A-V2 100 V AC: 7 VA max. 240 V AC: 10 VA max.</li> </ul> <p>(2) CPU Units with three Expansion I/O Units</p> <ul style="list-style-type: none"> <li>• ZEN-10C1AR-A-V2 /ZEN-10C2AR-A-V2 100 V AC: 6 VA max. 240 V AC: 8 VA max.</li> <li>• ZEN-10C4AR-A-V2 100 V AC: 7 VA max. 240 V AC: 9 VA max.</li> <li>• ZEN-20C□AR-A-V2 100 V AC: 8 VA max. 240 V AC: 11 VA max.</li> </ul> <p>(3) Expansion I/O Units ZEN-8E1AR 100 V AC: 3 VA max. 240 V AC: 4 VA max.</p>	<p>(1) CPU Units without Expansion I/O Units</p> <ul style="list-style-type: none"> <li>• ZEN-10C□DR-D-V2 12/24 V DC: 3 W max. (ZEN-10C3DR-D-V2: 2.8 W max.)</li> <li>• ZEN-10C□DT-D-V2 12/24 V DC: 2 W max.</li> <li>• ZEN-20C□DR-D-V2 12/24 V DC: 4 W max.</li> <li>• ZEN-20C□DT-D-V2 12/24 V DC: 2 W max.</li> </ul> <p>(2) CPU Units with three Expansion I/O Units</p> <ul style="list-style-type: none"> <li>• ZEN-10C□DR-D-V2 12/24 V DC: 4 W max.</li> <li>• ZEN-10C□DT-D-V2 12/24 V DC: 3 W max.</li> <li>• ZEN-20C□DR-D-V2 12/24 V DC: 5 W max.</li> <li>• ZEN-20C□DT-D-V2 12/24 V DC: 3 W max.</li> </ul> <p>(3) Expansion I/O Units • ZEN-8E1DR 12/24 V DC: 2 W max.</p>
Inrush current	ZEN-10C□AR-A-V2: 4.5 A max. ZEN-20C□AR-A-V2: 4.5 A max. ZEN-8E1AR: 4 A max.	ZEN-10C□D□-D-V2: 30 A max. ZEN-20C□D□-D-V2: 30 A max. ZEN-8E1DR: 15 A max.
Ambient temperature	0 to 55°C (-25 to 55°C for LED type CPU Units)	
Ambient humidity	10% to 90% (with no condensation)	
Storage temperature	-20 to 75°C (-40 to 75°C for LED type CPU Units)	
Terminal block	Tightening torque: 0.565 to 0.6 N·m (5 to 5.3 in·lb)	
Degree of protection	IP20 (Mounted inside a control panel)	

## Performance Specifications

Item	Specifications
LCD display	12 characters x 4 lines with backlight (not provided for LED-type CPU Units)
Operation buttons	8 buttons (4 cursor buttons and 4 operation buttons) (not provided for LED-type CPU Units)
User program memory	EEPROM built into CPU Unit and Memory Cassettes (optional)
Data backup for power interruptions	Internal holding bit status, holding timer/counter present values, calendar and clock (year, month, day of month, day of week, time) Super capacitor backup time: 2 days max. (at 25°C) Life of optional battery: 10 years max. (at 25°C)
Calendar/time	Accuracy: $\pm 15$ s/month (at 25°C) (not provided for LED-type CPU Units)
Timer accuracy	0.01 s unit: $-0.05\%$ – 10 ms max. Rated against set value min/s unit: $-0.05\%$ – 1 s max. Rated against set value h/min unit: $-0.05\%$ – 1 min max. Rated against set value
Maximum counting speed	150 Hz: 8-Digit counter (F) set to high-speed operations (CPU Units with DC power supplies only) (The counting speed may be less than 150 Hz depending on the cycle time of the program. See page 79.)
Insulation resistance	20 M $\Omega$ (at 500 VDC) min.: Between power supply terminals and all output terminals. Between terminals of different output circuits. Between all terminals of CPU Unit and all terminals of Expansion I/O Unit.
Insulation	<ul style="list-style-type: none"> <li>• Reinforced insulation Between power supply or input terminals and output terminals. Between terminals of different output circuits. Between all terminals of CPU Unit and all terminals of Expansion I/O Unit.</li> <li>• No separation Between power supply and input terminals of the same unit. Between power supply terminals of CPU Unit and computer connector, Battery Unit connector, or all Expansion Unit connectors (all interfaces are live parts).</li> </ul>
Dielectric strength	2300 VAC, 50/60 Hz for 1 min (leakage current 1 mA max.): Between power supply terminals and all output terminals. Between terminals of different output circuit. Between all terminals of CPU Unit and all terminals of Expansion I/O Unit.
Vibration resistance	Conforms to IEC 60068-2-6, 5 to 9 Hz, single amplitude: 3.5 mm, 9 to 150 Hz, acceleration: 9.8 m/s <sup>2</sup> , 10 sweeps each in X, Y, and Z directions (1 octave/min)
Shock resistance	Conforms to IEC 60068-2-27, 147 m/s <sup>2</sup> , 3 times each in X, Y, and Z directions
Weight	CPU Units with 10 I/O points: Approx. 300 g CPU Units with 20 I/O points: Approx. 350 g Expansion I/O Units: Approx. 120 g



## Approved Standards

<b>Safety standard</b>	cULus: UL508/CSA C22.2 No.142 Class I Div2 EN/IEC 61131-2 clause 11, excluding 11.7.2.2 (Overvoltage category 2 and Pollution degree II conform to IEC 60664-1.)		
<b>EMC (See note 1.)</b>	Radiation Field Emission	CISPR11	Class A, Group 1
	Noise Terminal Voltage Emission	CISPR11	Class A, Group 1
	Electrostatic Discharge Immunity	IEC 61000-4-2	In air: 8 kV, In contact: 6 kV
	Electromagnetic Field Immunity	IEC 61000-4-3	10 V/m
	Electrical Fast Transient/Burst Immunity	IEC 61000-4-4	Power line AC I/O: 2 kV DC I/O: 1 kV
	Surge immunity	IEC 61000-4-5	Normal Noise AC power supply, AC I/O: 1 kV DC power supply, DC I/O: 0.5 kV Common Noise AC power supply, AC I/O: 2 kV DC power supply: 1 kV DC I/O: 0.5 kV
	Immunity to Conducted Disturbances Induced by Radio-frequency Fields	IEC 61000-4-6	3 V
Momentary Power Interruption Immunity	IEC 61131-2	CPU Units with AC Power Supplies: 10 ms max. CPU Units with DC Power Supplies: 2 ms max. (level: PS1)	

**Note**

1. EMC conforms to EN 61131-2 clause 8 except in the following cases.
  - When Expansion I/O Units with DC inputs are connected to a CPU Unit with an AC power supply, the burst immunity will be 1 kv.
  - When the signal wire for transistor outputs exceeds 10 m, the surge immunity of DC output signal lines will not conform.

## Specifications

Item	Specifications	
Control method	Stored program control	
I/O control method	Cyclic scan	
Programming language	Ladder diagram	
Program capacity	96 lines (up to 3 inputs and 1 output per line)	
Maximum No. of control I/O points	CPU Units with 10 I/O points	34 points (with 3 Expansion I/O Units) (See note 1.)
	CPU Units with 20 I/O points	44 points (with 3 Expansion I/O Units)
Memory areas	CPU Unit input bits (I)	CPU Units with 10 I/O Points: I0 to I5, 6 bits
		CPU Units with 20 I/O Points: I0 to Ib, 12 bits
	CPU Unit output bits (Q)	CPU Units with 10 I/O Points: Q0 to Q3, 4 bits (See note 2.)
		CPU Units with 20 I/O Points: Q0 to Q7, 8 bits
	Expansion I/O Unit input bits (X)	X0 to Xb, 12 bits (See note 3.)
	Expansion I/O Unit output bits (Y)	Y0 to Yb, 12 bits (See note 3.)
	Work bits (M)	M0 to Mf, 16 bits
	Holding bits (H)	H0 to Hf, 16 bits
	Button switches (B)	B0 to B7, 8 bits (not supported for LED-type CPU Units)
	Timers (T)	T0 to Tf, 16 timers
	Holding timers (#)	#0 to #7, 8 timers
	Weekly timers (@)	@0 to @f, 16 timers (not supported for LED-type CPU Units)
	Calender timers (*)	*0 to *f, 16 timers (not supported for LED-type CPU Units)
	Counters (C)	C0 to Cf, 16 counters
	8-Digit Counter (F)	F0, 1 counter
	Display bits (D)	D0 to Df, 16 bits (not supported for LED-type CPU Units)
Analog comparator (A)	A0 to A3, 4 comparators (CPU Units with DC power supply only)	
Comparator (P)	P0 to Pf, 16 comparators	
8-Digit comparator (G)	G0 to G3, 4 comparators	

### Note

1. Communications-type CPU Units have only 33 points.
2. Output bit Q3 of CPU Units with communications cannot be output externally. It can be used as a work bit.
3. Can be used only when Expansion I/O Units are connected.

# Input Specifications

## CPU Units

### AC Inputs (Not Isolated)

Item	Specifications	Circuit drawing
Input voltage	100 to 240 VAC +10%, -15%, 50/60 Hz	
Input impedance	680 kΩ	
Input current	0.15 mA/100 VAC, 0.35 mA/240 VAC	
ON voltage	80 VAC min.	
OFF voltage	25 VAC max.	
ON response time	50 ms or 70 ms at 100 VAC (See note.)	
OFF response time	100 ms or 120 ms at 240 VAC (See note.)	

**Note** Can be selected using the input filter settings.

### DC Inputs I0 to I3 (I0 to I9 for Units with 20 I/O Points) (Not Isolated)

Item	Specifications	Circuit drawing
Input voltage	12 to 24 VDC +20%, -10%	
Input impedance	5.3 kΩ	
Input current	4.5 mA Typical (24 VDC)	
ON voltage	8 VDC min.	
OFF voltage	5 VDC max.	
ON response time	15 ms or 50 ms (See note.)	
OFF response time		

**Note** Can be selected using the input filter settings, except when I0 is being used for high-speed input.

**DC Inputs I4 and I5 (Ia and Ib for Units with 20 I/O points) (Not Isolated)**

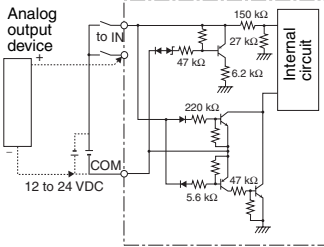
Item		Specifications	Circuit drawing
DC inputs	Input voltage	12 to 24 VDC +20%, -10%	 <p>* When using analog function.</p>
	Input impedance	PNP: 5.5 kΩ (14 VDC min.) 100 kΩ (14 VDC max.) NPN: 5.2 kΩ	
	Input current	PNP: 4.3 mA, Typical (24 VDC) NPN: 4.6 mA, Typical (24 VDC)	
	ON voltage	8 VDC min.	
	OFF voltage	3 VDC max.	
	ON response time	15 ms or 50 ms (See note.)	
	OFF response time		
Analog inputs	Input range	0 to 10 V	
	External input impedance	100 kΩ min.	
	Resolution	0.1 V (1/100 FS)	
	Accuracy	±1.5% FS (Within rated ambient operating temperature range)	
	AD conversion data	0 to 10.5 V in 0.1 V increments data	

**Note** Can be selected using the input filter settings.

**Expansion I/O Units**

**AC Inputs (Not Isolated)**

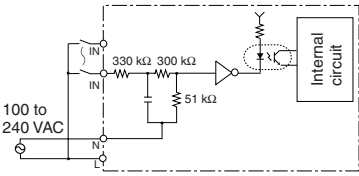
Item	Specifications	Circuit drawing
Input voltage	100 to 240 VAC +10%, -15%, 50/60 Hz	
Input impedance	680 kΩ	
Input current	0.15 mA/100 VAC, 0.35 mA/240 VAC	
ON voltage	80 VAC min.	
OFF voltage	25 VAC max.	
ON response time	50 ms or 70 ms at 100 VAC (See note.) 100 ms or 120 ms at 240 VAC (See note.)	
OFF response time		

**Note** Can be selected using the input filter settings.

**DC Inputs (ZEN-8E1DR Not Isolated)**

Item	Specifications	Circuit drawing
Input voltage	12 to 24 VDC +20%, -10%	
Input impedance	6.5 kΩ	
Input current	3.7 mA, Typical (24 VDC)	
ON voltage	8 VDC min.	
OFF voltage	5 VDC max.	
ON response time	15 ms or 50 ms (See note.)	
OFF response time		

**Note** Can be selected using the input filter settings.

**DC Inputs (ZEN-8E1DT: Photocoupler Isolated)**

Item	Specifications	Circuit drawing
Input voltage	12 to 24 VDC +20%, -15%	
Input impedance	6.5 kΩ	
Input current	3.7 mA, Typical (24 VDC)	
ON voltage	8 VDC min.	
OFF voltage	5 VDC max.	
ON response time	15 ms or 50 ms (See note.)	
OFF response time		

**Note** Can be selected using the input filter settings.

**Output Specifications**

**Relay Output Type (CPU Unit/Expansion I/O Units)**

Item	Specifications	Circuit drawing	
Max. switching capacity	250 VAC/8 A (cosφ = 1) 24 VDC/5 A  The total for all outputs must be as follows for each Unit: 10-point CPU Unit: 20 A max. Communications-type CPU Units: 15 A max. 20-point CPU Unit: 40 A max. Expansion I/O Unit: 20 A max.	<p>Each circuit is made up of an independent common circuit.</p> <p>20-point I/O models only</p>	
Min. switching capacity	5 VDC, 10 mA		
Relay durability	Electrical		Resistive load: 50,000 times Inductive load: 50,000 times (cosφ = 0.4)
	Mechanical		10 million times
ON response time	15 ms max.		
OFF response time	5 ms max.		

Guidelines for the normal durability of the ZEN relay outputs are shown in the following diagram.

Usage: 360 times/hour

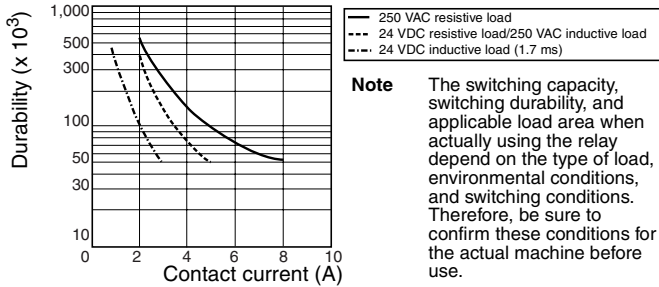

**Note** The switching capacity, switching durability, and applicable load area when actually using the relay depend on the type of load, environmental conditions, and switching conditions. Therefore, be sure to confirm these conditions for the actual machine before use.

### Transistor Output Type (CPU Unit/Expansion I/O Units)

Item	Specifications	Circuit drawing
Max. switching capacity	24 VDC +20%, 500 mA	Each circuit is made up of an independent common circuit. 
Leakage current	0.1 mA max.	
Residual voltage	1.5 V max.	
ON response time	1 ms max.	
OFF response time	1 ms max.	

# External Dimensions

- CPU Units with 10 I/O Points  
ZEN-10C□□□-□-V2

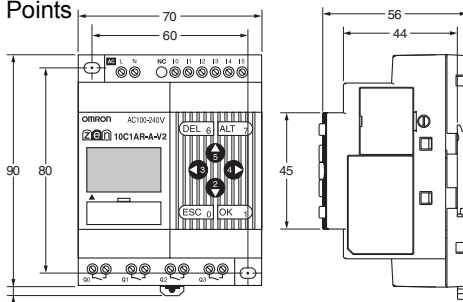
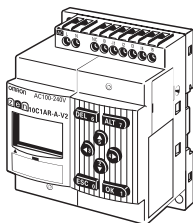

4.7  
(With slide: 13 max.)

- CPU Units with 20 I/O Points  
ZEN-20C□□□-□-V2

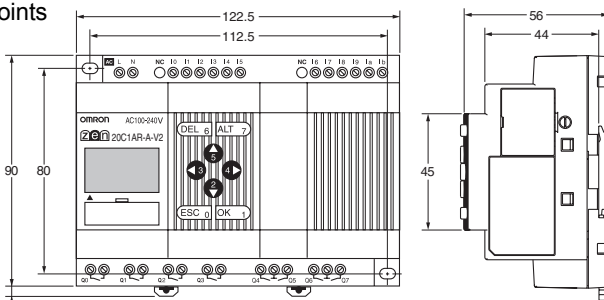
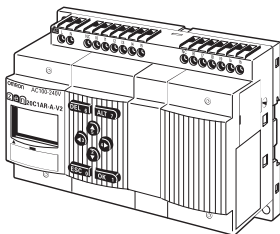

4.7  
(With slide: 13 max.)

- Dimensions with the Battery Unit Mounted

## CPU Units with 10 I/O Points

## CPU Units with 20 I/O Points

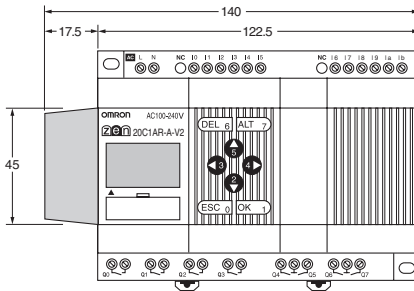
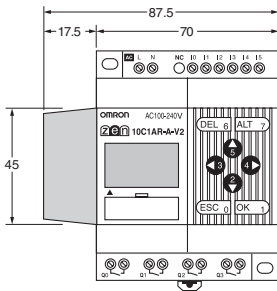
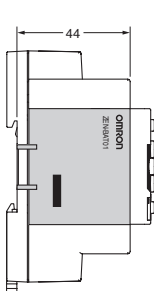

• Expansion I/O Units  
ZEN-8E1□□

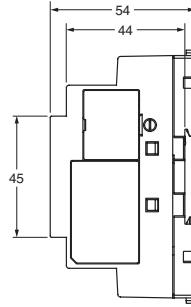
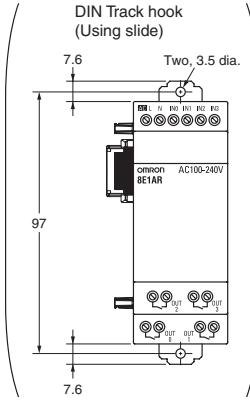
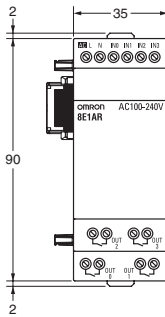
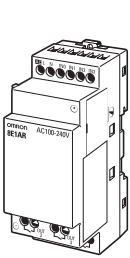

• Switching Power Supply Unit  
ZEN-PA03024

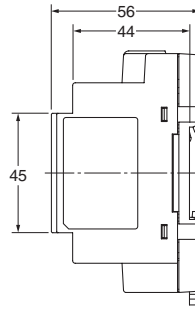
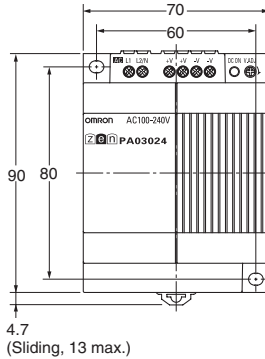
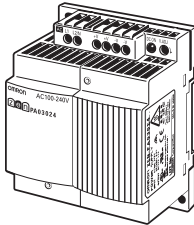



# Appendix B

## Ladder Program Execution

### Executing Ladder Programs

ZEN executes up to 96 lines of a ladder program in one cycle from first to last line. Starting from the first line of the bus bar, the ZEN repeatedly executes each line from left to right.

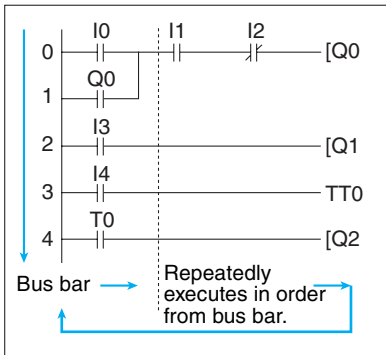

#### Note

1. The time from when processing starts at the bus bar until the bus bar is returned to at the first line again to execute the entire ladder program is called cycle time.
2. The output ON/OFF results cannot be used for inputs within the same cycle. The result scan can be used from the next cycle onwards.

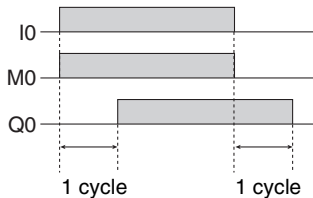
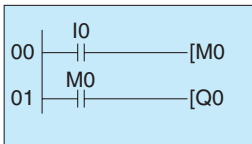

The Q0 ON/OFF result is reflected one cycle after M0 turns ON or OFF.

## Cycle Time Calculation Method

Cycle time ( $\mu\text{s}$ )	=	Common processing time	+	Processing time taken when Expansion I/O Units are connected	+	Ladder program execution time	+	Communications processing time (only for CPU Units with communications)
------------------------------	---	------------------------	---	--	---	-------------------------------	---	---

Refer to the following table for ZEN execution times. The execution times are provided as a guide. External factors, button operations, execution of ZEN Support Software operations, and timing of the processing affects the actual processing times.

### Common Processing Time

Unit type	Common processing time
Standard LCD-type CPU Units, Economy-type CPU Units, and Communications-type CPU Units	850 $\mu\text{s}$
LED-type CPU Units	200 $\mu\text{s}$

### Expansion I/O Unit Processing Time

Unit type	Expansion I/O Unit processing time
Expansion I/O Units	160 $\mu\text{s}$ per Unit

### Communications Processing Time (only for CPU Units with Communications)

Reading information	170 $\mu\text{s}$
Writing set values	Twin timer: 11,000 $\mu\text{s}$ Others: 6,000 $\mu\text{s}$
Writing time information	820 $\mu\text{s}$

**Ladder Program Execution Time**

Per line		30 μs: Line containing program 7 μs: Empty lines	*1
Per output	CPU Unit output bits (Q)	4 μs	*2
	Expansion I/O Unit output bits (Y)		
	Work bits (M)		
	Holding bits (H)		
	Timers (T)/Holding timers (#)	15 μs	*3
	Counters (C)/8-Digit Counters (F)	13 μs	
	Display bits (D)	Hour and minute (CLK)/Year and month (DAT)/Month and day (DAT1): 21 μs Timers (T)/Holding timers (#)/Counters (C)/Analog comparators: 28 μs Characters (CHR)/8-Digit Counters (F): 38 μs	
Weekly timers (@)		4 μs	*4
Calendar timers (*)		1 μs	
Analog comparators (A)		3 μs	
Comparators (P)		7 μs	*5
8-Digit Comparators (G)		4 μs	

**Example Calculation of Ladder Program Execution Time**

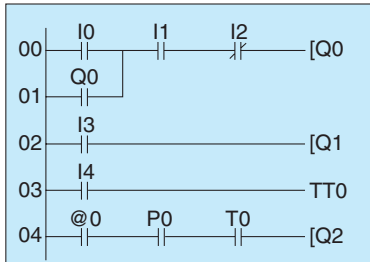

Ladder program execution time =  
 $(30 \times 5) + (4 \times 3) + 15 + 4 + 7 = 188 \text{ (}\mu\text{s)}$

↑ \*1: For 5 lines  
 ↑ \*2: Q (outputs) for 3 points  
 ↑ \*3: T0 (output)  
 ↑ \*4: @0  
 ↑ \*5: P0



# Appendix C

## Operating Mode at Startup

The operating mode at startup depends on the model and the presence of a user program as shown in the following table.

User program	In CPU	No	Yes	No	Yes
	In Memory Cassette	No	No	Yes	Yes
LCD-type CPU Unit		STOP mode	RUN mode with program in CPU	STOP mode with program in Memory Cassette	RUN mode with program in CPU
LED-type CPU Unit (without LCD)		STOP mode	RUN mode with program in CPU	RUN mode with program automatically loaded from Memory Cassette	RUN mode with program automatically loaded from Memory Cassette

Yes: Indicates that the user ladder program and parameter settings are correctly written.

No: Indicates that the user ladder program and parameter settings are not written or that the data is not correct.



# Appendix D

## Version Upgrades

The following table shows the relationship between the versions and functionality of the ZEN CPU Unit and ZEN Support Software.

Date of upgrade	CPU Unit		Support Software
	System software version	Main changes	
January 2002	Ver. 1.1	<p>The following functions were added to the displays.</p> <ul style="list-style-type: none"> <li>• A Clear Display function</li> <li>• A Day/Month display object (DAT1)</li> </ul>	<p>The following functions were added to version 2.0 (ZEN-SOFT01-V2).</p> <ul style="list-style-type: none"> <li>• Support for changes to display function</li> <li>• Simulation function</li> <li>• Improvements to functions, operating procedures, and displays</li> </ul>
May 2003	Ver. 2.0	<ul style="list-style-type: none"> <li>• The number of timers, counters, weekly timers, calendar timers, and display areas was increased from 8 to 16 each and the number of holding timers was increased from 4 to 8.</li> <li>• A new CPU Unit with 20 I/O points was added.</li> <li>• The input circuits of CPU Units with DC power supply were made compatible with both PNP and NPN.</li> <li>• A password input was added to the memory all clear function.</li> <li>• The model numbers of CPU Units end in “-V1.”</li> </ul>	<p>The following functions were added to version 3.0 (ZEN-SOFT01-V3).</p> <ul style="list-style-type: none"> <li>• Support for V1 CPU Units with 20 I/O points</li> <li>• Support for V1 CPU Units with 10 I/O points</li> </ul>
February 2006	Ver. 3.0	<ul style="list-style-type: none"> <li>• Multiple-day operation and pulse-output operation were added to weekly timers.</li> <li>• Twin timer operation was added to the timers.</li> <li>• An 8-digit counter and 8-digit comparators were added.</li> <li>• The power supply voltage for CPU Units with DC power supplies and the transistor output voltage range was increased to 10.8 to 28.9 VDC.</li> <li>• The accuracy of weekly timers and calendar timers was increased to <math>\pm 15</math> s or less per month (at 25°C).</li> <li>• The accuracy of analog inputs was increased to <math>\pm 1.5\%</math> FS.</li> <li>• Daylight Saving Time (DST) settings were added for Australia and New Zealand.</li> <li>• Connectable Expansion I/O Units: ZEN-8E1 types only.</li> <li>• Economy-type CPU Units and Communications-type CPU Units were added.</li> <li>• Use the ZEN-SOFT01-V4 Support Software</li> </ul> <p><b>Note</b> The model numbers of CPU Units end in “-V2.”</p>	<p>Support for the following Units was added to version 4.1 (ZEN-SOFT01-V4).</p> <ul style="list-style-type: none"> <li>• V2 CPU Units with 20 I/O Points</li> <li>• V2 CPU Units with 10 I/O points</li> <li>• Half-size Expansion I/O Units (-8E1).</li> </ul>

**Note** The number of the system software version in the CPU Unit is not related to the model number. The system software version of CPU Units with LCDs can be read by selecting **SYSTEM INFO** from the **OTHER** Menu. “V03.00” will be displayed as the system software version for V2 CPU Units.

## Differences between CPU Units

### Specifications

Item		V2 CPU Units	V1 and Pre-V1 CPU Units
Structure		Heat dissipation slits removed.	---
Mounting direction		Standard (Vertical) Installation and Horizontal Installation	Standard (Vertical) Installation
Power supply voltage for DC-input Models		10.8 to 28.8 VDC	20.4 to 26.4 VDC
Inrush current	CPU Units with AC power supply	4.5 A max.	40 A max.
	CPU Units with DC power supply	30 A max.	20 A max.
Time accuracy		±15 s/month (at 25°C)	±2 min/month
Internal bits	Timers	Twin operation added.	ON delay, OFF delay, One-shot pulse, and Flashing pulse operation
	Weekly timers	Multiple-day operation and pulse operation added.	Only normal operation possible.
	Additions	8-Digit counter (150 Hz, 1 counter) 8-Digit comparator	---
Daylight Saving Time (DST)		Australia and New Zealand added.	Manual, Europe, and America
LCD contrast adjustment		Not required.	Supported.
Menu displays		Node number setting deleted.	---
Connectable Expansion I/O Units		ZEN-8E1□ (See note.)	ZEN-4E□ and ZEN-8E□
RS-485 communications		CPU Units with RS-485 communications added (ZEN-10C4□R-□-V2).	None

**Note** Refer to page 138 for details on compatible combinations of CPU Units and Expansion I/O Units.



**Memory Areas**

Area	CPU Unit				
	V2 CPU Units		V1 CPU Units		Pre-V1 CPU Units
	10-point	20-point	10-point	20-point	10-point
CPU Unit input bits (I)	6	12	6	12	6
CPU Unit output bits (Q)	4 (See note.)	8	4	8	4
Timers (T)	16				8
Holding timers (#)	8				4
Counters (C)	16				8
Weekly timers (@)	16				8
Calendar timers (* )	16				8
Displays (D)	16				8
Work bits (M)	16				
Holding bits (H)	16				
Expansion I/O Unit input bits (X)	12				
Expansion I/O Unit output bits (Y)	12				
Analog comparators (A)	4				
Comparators (P)	16				
8-Digit counter (F)	1		---		
8-Digit comparator (G)	4		---		

**Note** Output bit Q3 of CPU Units with communications cannot be output externally.

### Compatible Combinations of CPU Units and Expansion I/O Units

The Expansion I/O Units that can be connected to V2 CPU Units are different from those that can be connected to V1 CPU Units and previous CPU Units. Expansion I/O Units with AC Inputs cannot be connected to V2 CPU Units with DC Power Supplies. Expansion I/O Units cannot be connected to Economy-type CPU Units.

CPU Units				Supported Expansion I/O Units
Version	CPU Unit type	Power supply	Model	
V2	Standard LCD type LED type Communications type	AC	ZEN-□C1AR-A-V2	ZEN-8E1AR ZEN-8E1DR ZEN-8E1DT
			ZEN-□C2AR-A-V2	
			ZEN-10C4AR-A-V2	
	Standard LCD type LED type	DC	ZEN-□C1D□-D-V2	ZEN-8E1DR ZEN-8E1DT
			ZEN-□C2D□-D-V2	
	Economy type	AC	ZEN-□C3AR-A-V2	Not supported.
DC		ZEN-□C3DR-D-V2		
V1 and Pre-V1	Standard LCD type LED type	AC	ZEN-□C1AR-A-V1	ZEN-4EA ZEN-4ED ZEN-4ER ZEN-8EAR ZEN-8EDR ZEN-8EDT
			ZEN-□C1AR-A	
			ZEN-□C2AR-A-V1	
			ZEN-□C2AR-A	
		DC	ZEN-□C1D□-D-V1	
			ZEN-□C1D□-D ZEN-□C2D□-D-V1 ZEN-□C2D□-D	

### Input Specifications

#### DC Inputs I0 to I3 on Units with 10 I/O Points, I0 to I9 on Units with 20 I/O Points

Item	V2 CPU Units	V1 CPU Units	Pre-V1 CPU Units
Input voltage range	10.8 to 28.8 VDC	20.4 to 26.4 VDC	
Input impedance	5.3 kΩ	5 kΩ	4.8 kΩ
ON voltage	8 V	16 V	
Input commons	Independent common terminals		Internally connected to power supply terminal

#### DC Inputs I4 and I5 on Units with 10 I/O Points, Ia and Ib on Units with 20 I/O Points

Item		V2 CPU Units	V1 and Pre-V1 CPU Units
DC inputs	Input voltage range	10.8 to 28.8 VDC	20.4 to 26.4 VDC
	Input impedance	5.2 to 5.5 kΩ	5 kΩ
	ON voltage	8 V	16 V
	OFF voltage	3 V	5 V
Analog inputs	Input impedance	100 kΩ min.	150 kΩ min.
	Accuracy	±1.5% FS (Within rated ambient operating temperature range)	10% FS (Within rated ambient operating temperature range)

**Output Specifications**

Item	V2 CPU Units	V1 and Pre-V1 CPU Units
Contact current for Models with Relay Outputs	8 A/contact The total for all outputs for each Unit must be as follows: 10-point CPU Units: 20 A max. Communications-type CPU Units: 15 A max. 20-point CPU Units: 40 A max.	8 A/contact
Maximum voltage for Models with Transistor Outputs	28.8 VDC	26.4 VDC

## Differences in Expansion I/O Units

Item		ZEN-8E1□	ZEN-4E□ and ZEN-8E□
Type		8 inputs/outputs	4 inputs, 4 outputs, and 8 inputs/outputs
Shape		Width: 35 mm, no heat dissipation slits	Width: 70 mm
Screw mounting method		M3 (mounting holes on DIN Track)	M4 (holes on Expansion I/O Units)
Power supply		ZEN-8E1AR, -8E1DR: Required. ZEN-8E1DT: Not required.	Not required.
AC input circuits	Input impedance	680 kΩ	83 kΩ
	Isolation method	Not isolated	Photocoupler
	Input common	Connected internally to power supply terminal.	Separated as COM terminal.
DC input circuits	Input voltage	10.8 to 28.8 VDC	20.4 to 26.4 VDC
	ON voltage	8 V	16 V
	Input impedance	6.5 kΩ	4.7 kΩ
	Isolation method	ZEN-8E1DR: Not isolated ZEN-8E1DT: Photocoupler	Photocoupler
	Input common	ZEN-8E1DR: Connected internally to power supply terminal. ZEN-8E1DT: Separated as COM terminal.	Separated as COM terminal.
Contact current for Models with Relay Outputs		8 A/contact The total for all outputs must be as follows for each Unit: 20 A	8 A/contact
Maximum voltage for Models with Transistor Outputs		28.8 VDC	26.4 VDC
Connectable CPU Units		V2 CPU Units (See note.)	V1 and Pre-V1 CPU Units

**Note** Refer to page 138 for details on compatible combinations of CPU Units and Expansion I/O Units.

## Compatibility

### Memory Cassette Compatibility

Be aware of the following restrictions when using a Memory Cassette containing a program that was stored from a CPU Unit with a different version of system software.

Version of CPU Unit used to write the Memory Cassette		Version of CPU Unit used to read the Memory Cassette					
		Ver. 1.0	Ver. 1.1	Ver. 2.0 (V1 CPU Units)		Ver. 3.0 (V2 CPU Units)	
				10 I/O points	20 I/O points	10 I/O points	20 I/O points
Ver. 1.0		OK	OK	OK	OK	OK	OK
Ver. 1.1		Restrictions (See note 1.)	OK	OK	OK	OK	OK
Ver. 2.0 (V1 CPU Units)	10 I/O points	Restrictions (See notes 1 and 2.)	Restrictions (See note 2.)	OK	OK	OK	OK
	20 I/O points	Restrictions (See notes 1, 2, and 3.)	Restrictions (See notes 2 and 3.)	Restrictions (See note 3.)	OK	Restrictions (See note 3.)	OK
Ver. 3.0 (V2 CPU Units)	10 I/O points	Restrictions (See notes 1, 2, and 4.)	Restrictions (See notes 2 and 4.)	Restrictions (See note 4.)	Restrictions (See note 4.)	OK	OK
	20 I/O points	Restrictions (See notes 1 to 4.)	Restrictions (See notes 2, 3, and 4.)	Restrictions (See note 4.)	Restrictions (See note 4.)	Restrictions (See note 3.)	OK

#### Note

1. The display functions (display clear: -CD□ and day/month display: DAT1) cannot be used and will be ignored.
2. Only the memory area ranges supported by the pre-V1 CPU Units can be used for Timers, Holding Timers, Counters, Weekly Timers, Calendar Timers, and Displays (i.e., only half of each).
3. Only 6 inputs and 4 outputs can be used in the CPU Unit I/O bits. Any others will be ignored.
4. Twin timer operation for timers, operation between days and pulse operation for weekly timers, the 8-digit counter, and 8-digit comparators cannot be used. New Zealand and Australia cannot be set for Daylight Saving Time (DST).

**Compatibility of Programs Depending on Support Software Version**

CPU Unit system software		Support Software			
		Ver. 1.0 ZEN-SOFT01	Ver. 2.0 ZEN-SOFT01- V2	Ver. 3.0 ZEN-SOFT01- V3	Ver. 4.1 ZEN-SOFT01- V4
Ver. 1.0 (Pre-V1 Units)		OK	OK	Restrictions (See notes 1 and 2.)	Restrictions (See notes 1, 2, and 3.)
Ver. 1.1 (Pre-V1 Units)		Restrictions (See note 1.)	OK	Restrictions (See note 2.)	Restrictions (See notes 2 and 3.)
Ver. 2.0 (V1 CPU Units)	10 I/O points	Restrictions (See notes 1 and 2.)	Restrictions (See note 2.)	OK	Restrictions (See note 3.)
	20 I/O points	Not applicable.	Not applicable.	OK	Restrictions (See note 3.)
Ver. 3.0 (V2 CPU Units)		Not applicable.	Not applicable.	Not applicable.	OK

- Note
1. The display functions (display clear: -CD□ and day/month display: DAT1) cannot be used and will be ignored.
  2. Only the memory area ranges supported by the pre-V1 CPU Units can be used for Timers, Holding Timers, Counters, Weekly Timers, Calendar Timers, and Displays (i.e., only half of each).
  3. Twin timer operation for timers, multiple-day operation and pulse operation for weekly timers, the 8-digit counter, and 8-digit comparators cannot be used. New Zealand and Australia cannot be set for Daylight Saving Time (DST).

# Appendix E

## Application Examples

### Lighting Pattern Control

#### Application

The ZEN can help conserve energy if the lighting patterns required for offices and similar environments are set to the ZEN.

Use the switch operation to switch between lighting patterns.

Operation	Switch	Lighting group			
		1 (Q0)	2 (Q1)	3 (Q2)	4 (Q3)
All lights ON	SW 1 (I0)	ON	ON	ON	ON
Pattern 1	SW 2 (I1)	ON	OFF	ON	OFF
Pattern 2	SW 3 (I2)	ON	ON	OFF	OFF
All lights OFF	SW 4 (I3)	OFF	OFF	OFF	OFF

#### System Configuration



Note:  
Switches use momentary normally open contacts.

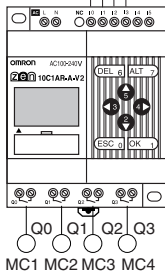

ZEN-10C1AR-A-V2

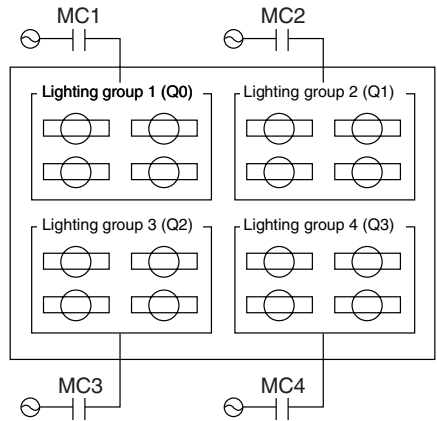

### Program Example

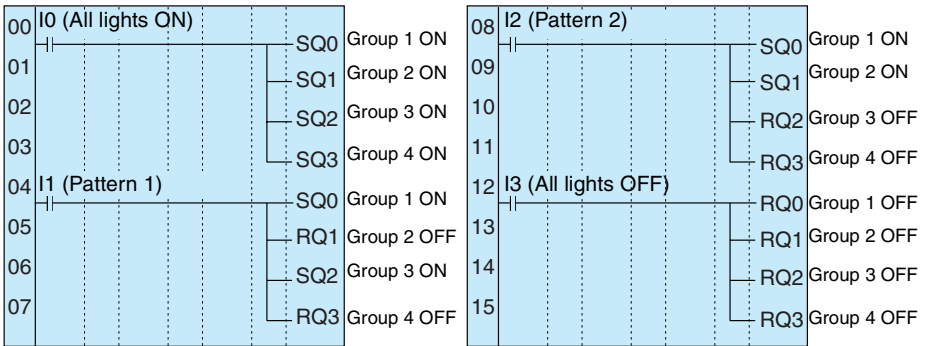

## Escalator with Automatic Operation Function (Weekly Timer, OFF Delay Timer)

### Application

The ZEN can be simply used to conserve energy for an escalator with an automatic operation function. The escalator can be set to operate continuously from 7:00 to 10:00 and 17:00 to 22:00 weekdays and then operate at other times and on weekends only when people approach the escalator.

### System Configuration

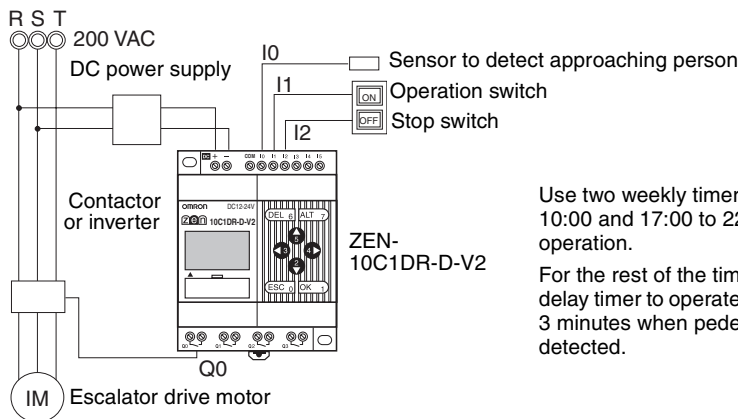

Use two weekly timers for the 7:00 to 10:00 and 17:00 to 22:00 weekday operation.

For the rest of the time, use an OFF delay timer to operate the escalator for 3 minutes when pedestrians are detected.



### Program Example

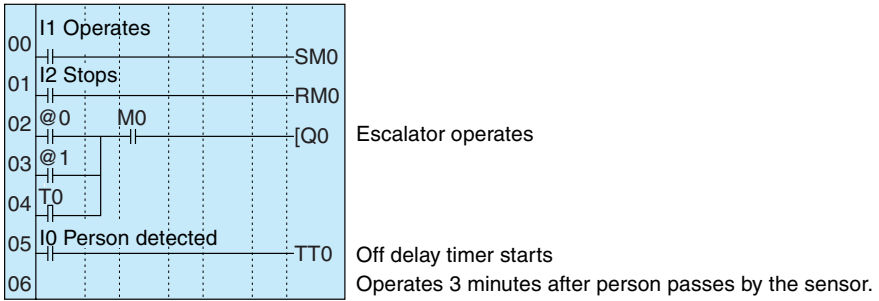

### Parameter Settings

Weekly timer @0

(Mon to Fri: 7:00 to 10:00)

@1	N	MO-FR	A
ON	17:00		
OFF	22:00		

Weekly timer @1

(Mon to Fri: 17:00 to 22:00)

@1	N	MO-FR	A
ON	17:00		
OFF	22:00		

OFF delay timer T0

T0	■	M:S A
TRG		
RES	03.00	

## Water Supply Tank Control

### Application

Basic water supply control is possible with the 61F Switch (without float) alone, however relay logic is required for inverter control of high-speed operation (when empty) and low-speed operation (when half-full).

# System Configuration

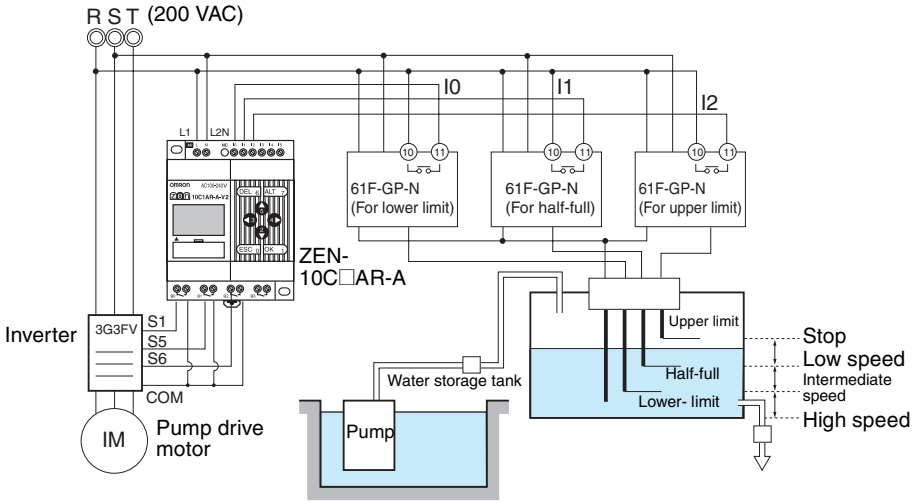

# Program Example

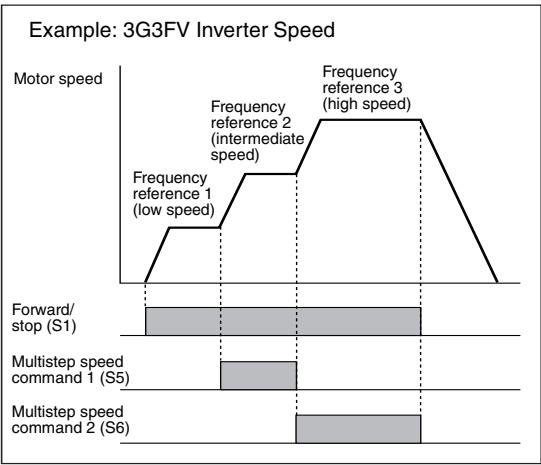
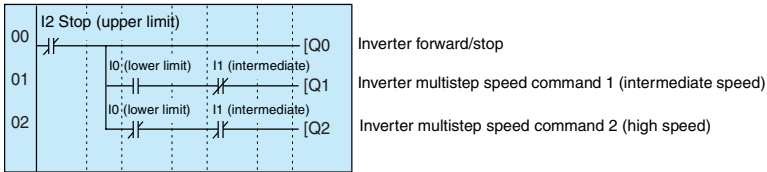

# Greenhouse Air Circulation Control (1/3) (Bit Logic and Timer)

## Application

The ZEN can be used to control circulation intermittently at set times. This circulates the carbon dioxide and warm air around plants in a greenhouse.

In this example, two circulation fans are operated at set intervals. The starting current is kept to a minimum and, as a result, the circulation fans are set to start operating at different times.

## System Configuration

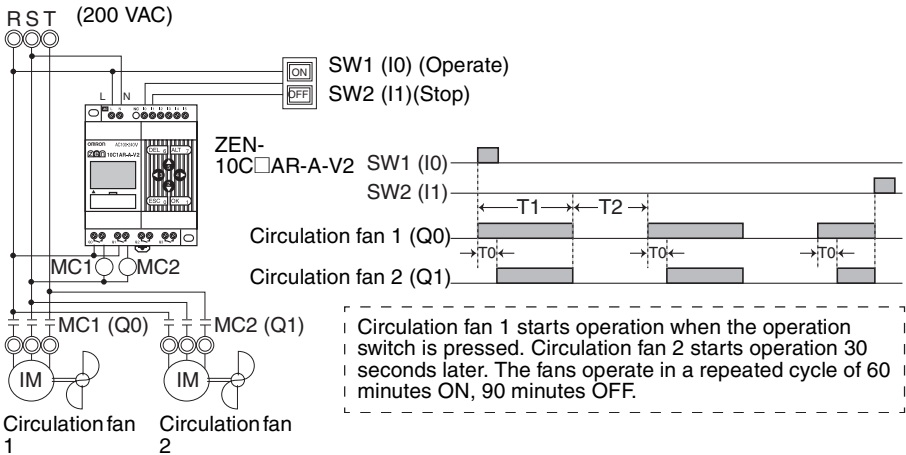

## Program Example

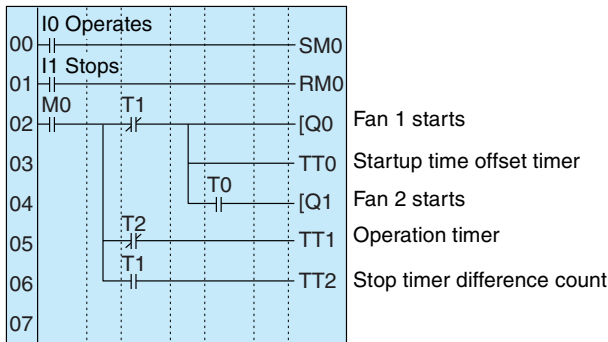

**Parameter Settings**

Offset start timer  
setting T0

T0	X	S	A
TRG			
RES		30.00	

Set to 30 seconds.

Operation timer setting T1

T1	X	H:M	A
TRG			
RES		01.00	

Set to 1 hour.

Operation timer setting T2

T2	X	H:M	A
TRG			
RES		01.30	

Set to 1 hour 30 seconds.

## Greenhouse Air Circulation Control (2/3) (Calendar Timer and Weekly Timer)

### Application

The ZEN can be used to operate circulation fans during winter nights only.

In this example, the circulation fans operate only at night (19:00 to 6:00) during winter (November 15 to March 20).

During the operation period, the fans operate intermittently, 60 minutes ON, 30 minutes OFF. The low startup current results in a 30 second difference in the fan startup times.

The start and stop operation days during winter (November 15 and March 20) are set using the calendar timer (\*0).

The start and stop operation times during the night (19:00 and 6:00) are set using the weekly timer (@0).

The startup time difference and operate/stop cycles are set using the timer (T0 to T2).

### System Configuration

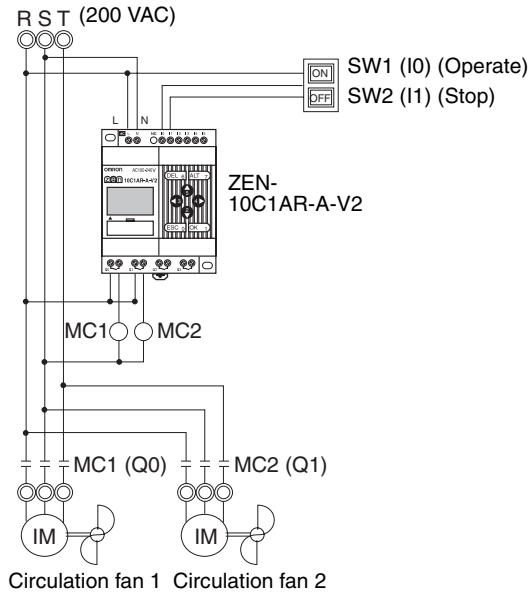

### Program Example

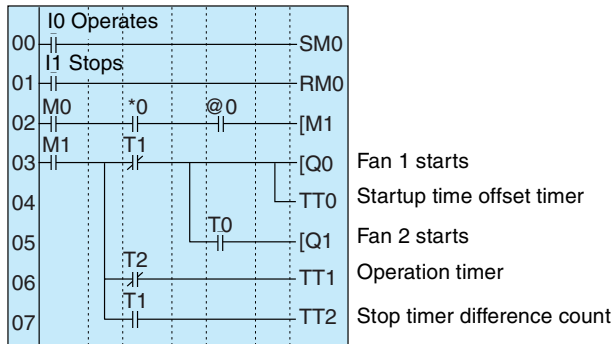

**Parameter Settings**

Calendar Timer Setting \*0

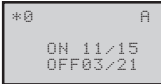

Start on Nov 15 and stop on Mar 20

Weekly timer setting @0

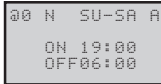

Start at 19:00 and stop at 6:00

Offset startup time setting T0

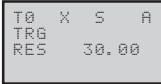

Set to 30 seconds.

Operation time setting T1

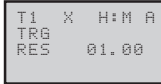

Set to 1 hour.

Stop time setting T2

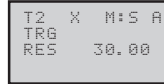

Set to 30 minutes.

## Greenhouse Air Circulation Control (3/3) (Analog Comparator)

### Application

The ZEN can be used to start the circulation fans once the temperature has reached a set level. A low startup current would result from a difference in the fan startup times.

### System Configuration

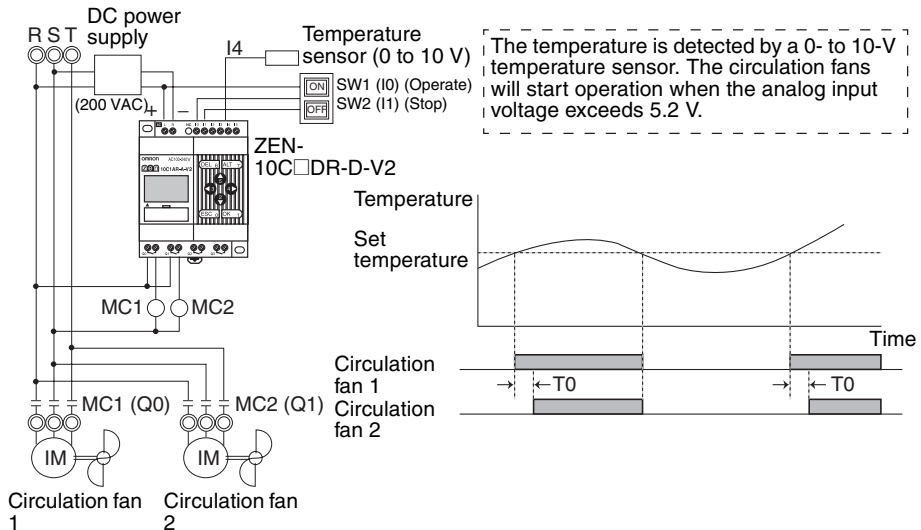

## Program Example

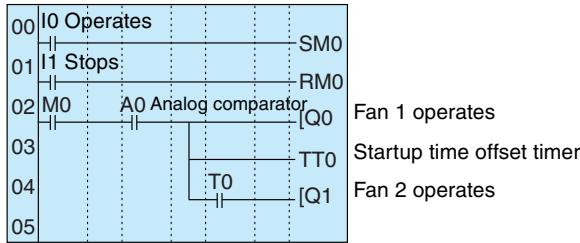

### Parameter Settings

Analog Comparator A0

Offset startup timer setting T0

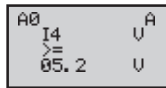

Set temperature  $\geq$  5.2V

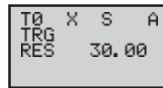

Set to 30 seconds.

## Annunciator (Flashing Pulse Timer)

### Application

The ZEN can be used to make an alarm light flash when errors occur.

In this example, a flashing pulse timer is used to make an alarm light flash when errors occur. Ladder programs can be created easily when a flashing pulse timer is used.

### System Configuration

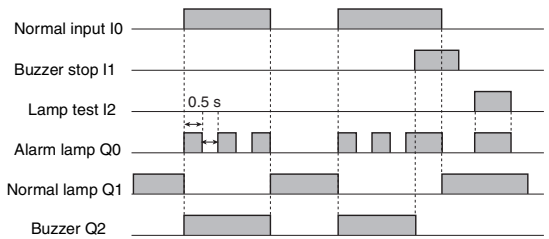
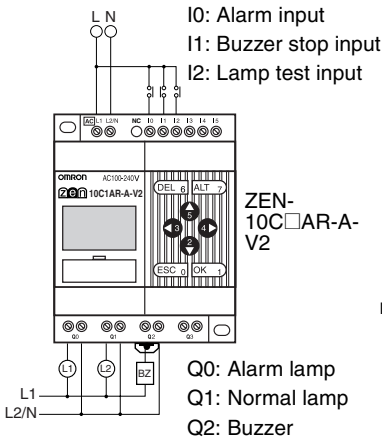

## Program Example

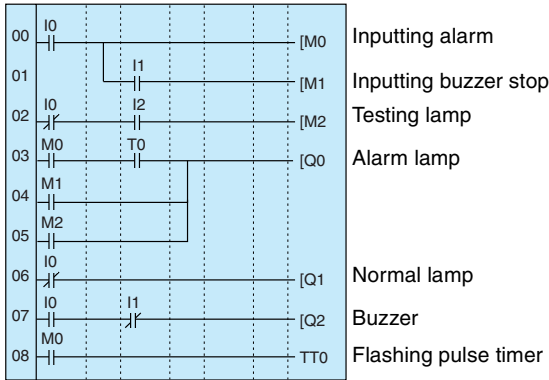

### Parameter Settings

Flashing Pulse Timer

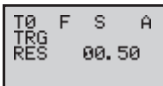

Set to flash at 0.5 s intervals.

## Coin-operated Carwash (Holding Bits and Holding Timer)

### Application

The ZEN can be used to change the operating time of a machine, such as a coin-operated car wash, depending on the number of coins inserted.

If a holding timer is used and holding bits used for the self-holding bits, the remaining time will not be reset if there are unexpected power interruptions.

In this example, the carwash operates for 3 minutes if one coin is inserted, 6 minutes if two coins are inserted, and 9 minutes if 3 coins are inserted.

A holding timer is used as the timer.



# System Configuration

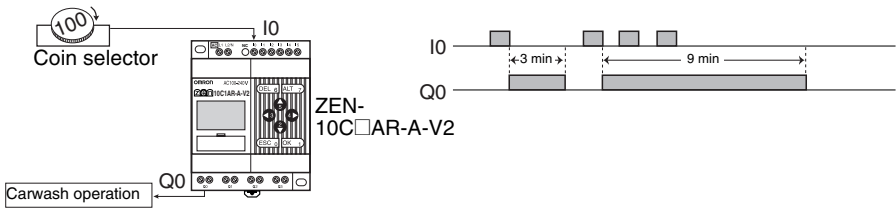

# Program Example

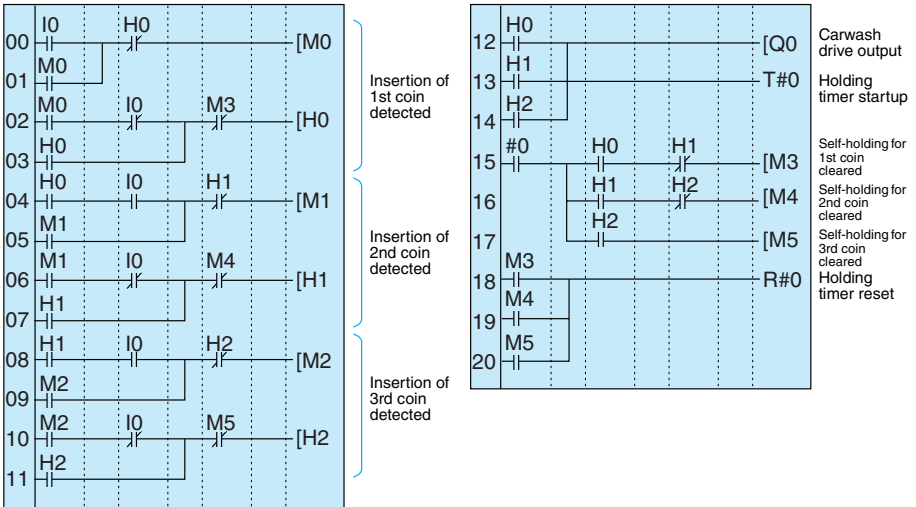

# Parameter Settings

Holding Timer

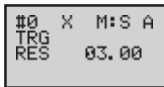

Set to 3 minutes.

# Warming Molding Machines (Weekly Timer and Bit Logic)

## Application

The ZEN can be used to improve molding efficiency by warming up the molding machine before the work shift starts. This allows molding work to begin immediately at the start of the work shift.

When work shifts vary, pre-set weekly timers can be selected using a switch.

## System Configuration

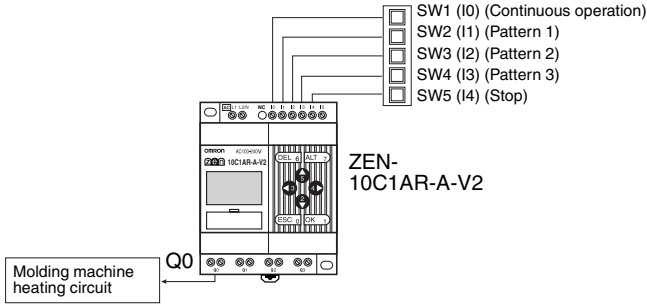

### Program Example

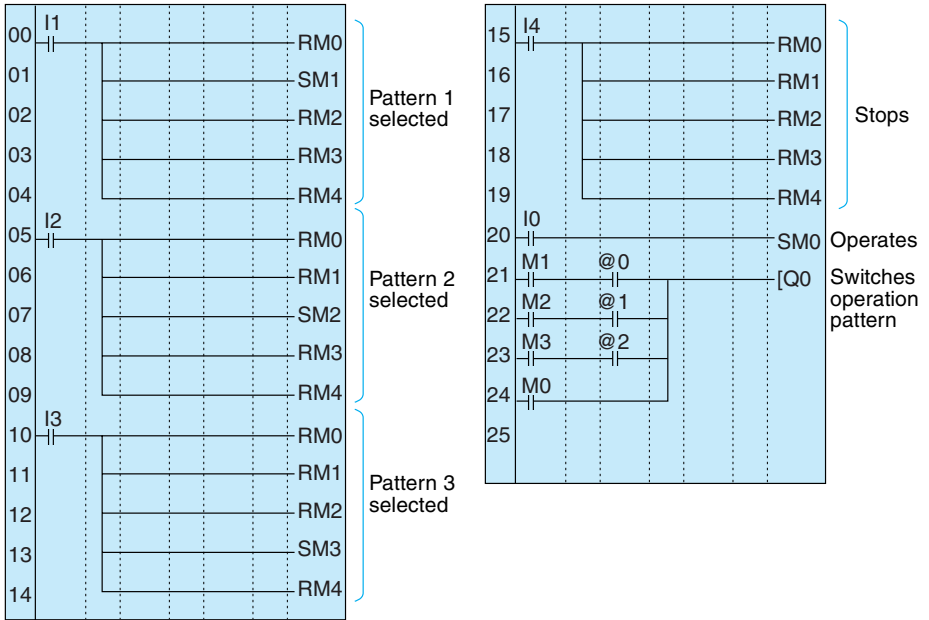

### Parameter Settings

Weekly Timer Setting @0 to @2





# Appendix F

## Allocations and Setting Table

### I/O Allocations for the ZEN-10C□□□-□-V2

I/O	Unit name	Bit	Input device name	Input	IN filter
Input bits	CPU Unit	I0		AC DC V	Yes No
		I1			
		I2			
		I3			
		I4	Normal input Analog voltage input		
	Expansion I/O Unit	X0		AC DC V	Yes No
		X1			
		X2			
		X3			
	Expansion I/O Unit	X4		AC DC V	Yes No
		X5			
		X6			
		X7			
	Expansion I/O Unit	X8		AC DC V	Yes No
		X9			
Xa					
Xb					

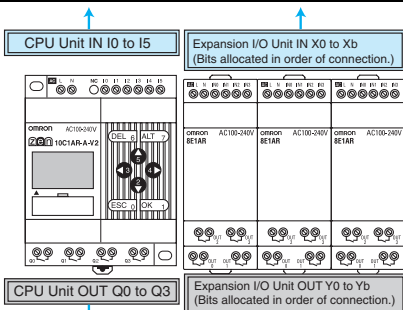

I/O	Unit name	Bit	Output device name and specifications
Output bits	CPU Unit	Q0	AC DC V A
		Q1	AC DC V A
		Q2	AC DC V A
		Q3*	AC DC V A
	Expansion I/O Unit	Y0	AC DC V A
		Y1	AC DC V A
		Y2	AC DC V A
	Expansion I/O Unit	Y3	AC DC V A
		Y4	AC DC V A
		Y5	AC DC V A
	Expansion I/O Unit	Y6	AC DC V A
		Y7	AC DC V A
		Y8	AC DC V A
		Y9	AC DC V A
Expansion I/O Unit	Ya	AC DC V A	
	Yb	AC DC V A	

\* Output bit Q3 of CPU Units with communications cannot be output externally. It can be used as a work bit.

# I/O Allocations for the ZEN-20C□□□-□-V2

I/O	Unit name	Bit	Input device name	Input	IN filter	
Input bits	CPU Unit	I0		AC DC V	Yes No	
		I1				
		I2				
		I3				
		I4				
		I5				
		I6				
		I7				
		I8				
		I9				
			1a	Normal input Analog voltage input	AC DC V	Yes No
			1b	Normal input Analog voltage input		
		Expansion I/O Unit	X0		AC DC V	Yes No
	X1					
	X2					
	X3					
	Expansion I/O Unit	X4		AC DC V	Yes No	
		X5				
		X6				
		X7				
	Expansion I/O Unit	X8		AC DC V	Yes No	
		X9				
		Xa				
		Xb				

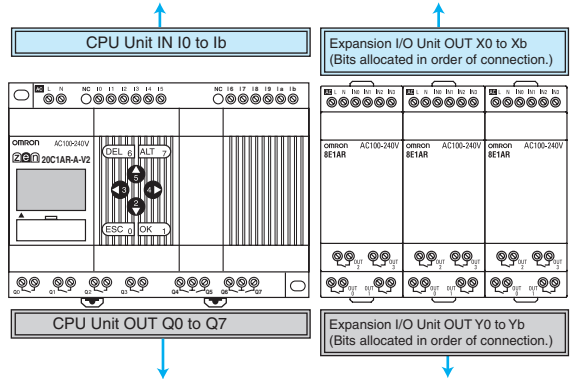

<b>I/O</b>	<b>Unit name</b>	<b>Bit</b>	<b>Output device name and specifications</b>
Output bits	CPU Unit	Q0	AC DC V A
		Q1	AC DC V A
		Q2	AC DC V A
		Q3	AC DC V A
		Q4	AC DC V A
		Q5	AC DC V A
		Q6	AC DC V A
		Q7	AC DC V A
	Expansion I/O Unit	Y0	AC DC V A
		Y1	AC DC V A
		Y2	AC DC V A
		Y3	AC DC V A
	Expansion I/O Unit	Y4	AC DC V A
		Y5	AC DC V A
		Y6	AC DC V A
		Y7	AC DC V A
	Expansion I/O Unit	Y8	AC DC V A
		Y9	AC DC V A
		Ya	AC DC V A
		Yb	AC DC V A

## Work and Holding Bit Allocations

Bit type	Address	Application	Bit type	Address	Application
Work bits	M0		Holding bits	H0	
	M1			H1	
	M2			H2	
	M3			H3	
	M4			H4	
	M5			H5	
	M6			H6	
	M7			H7	
	M8			H8	
	M9			H9	
	Ma			Ha	
	Mb			Hb	
	Mc			Hc	
	Md			Hd	
	Me			He	
Mf		Hf			

## Timer and Holding Timer Settings

Timer	Address	Operation setting (See note.)	Setting time unit 1	Setting time unit 2 (W only)	Set time	Application
Timer	T0	X ■ O F W	H:M M:S S	H:M M:S S		
	T1	X ■ O F W	H:M M:S S	H:M M:S S		
	T2	X ■ O F W	H:M M:S S	H:M M:S S		
	T3	X ■ O F W	H:M M:S S	H:M M:S S		
	T4	X ■ O F W	H:M M:S S	H:M M:S S		
	T5	X ■ O F W	H:M M:S S	H:M M:S S		
	T6	X ■ O F W	H:M M:S S	H:M M:S S		
	T7	X ■ O F W	H:M M:S S	H:M M:S S		
	T8	X ■ O F W	H:M M:S S	H:M M:S S		
	T9	X ■ O F W	H:M M:S S	H:M M:S S		
	Ta	X ■ O F W	H:M M:S S	H:M M:S S		
	Tb	X ■ O F W	H:M M:S S	H:M M:S S		
	Tc	X ■ O F W	H:M M:S S	H:M M:S S		
	Td	X ■ O F W	H:M M:S S	H:M M:S S		
	Te	X ■ O F W	H:M M:S S	H:M M:S S		
Tf	X ■ O F W	H:M M:S S	H:M M:S S			
Holding timer	#0	X	H:M M:S S	---		
	#1	X	H:M M:S S			
	#2	X	H:M M:S S			
	#3	X	H:M M:S S			
	#4	X	H:M M:S S			
	#5	X	H:M M:S S			
	#6	X	H:M M:S S			
	#7	X	H:M M:S S	---		

**Note** X: ON delay; ■: OFF delay; O: One-shot pulse; F: Flashing pulse; W: Twin timer



## Counter Settings

Counter address	Setting (No. of times)	Application	
C0			Incrementing: Decrementing: Reset:
C1			Incrementing: Decrementing: Reset:
C2			Incrementing: Decrementing: Reset:
C3			Incrementing: Decrementing: Reset:
C4			Incrementing: Decrementing: Reset:
C5			Incrementing: Decrementing: Reset:
C6			Incrementing: Decrementing: Reset:
C7			Incrementing: Decrementing: Reset:
C8			Incrementing: Decrementing: Reset:
C9			Incrementing: Decrementing: Reset:
Ca			Incrementing: Decrementing: Reset:
Cb			Incrementing: Decrementing: Reset:
Cc			Incrementing: Decrementing: Reset:
Cd			Incrementing: Decrementing: Reset:
Ce			Incrementing: Decrementing: Reset:
Cf			Incrementing: Decrementing: Reset:

## 8-Digit Counter Settings

Counter address	Setting (No. of times)	Counting speed		
F0		High	Low	Incrementing: Decrementing: Reset:

## Weekly Timer Settings

Weekly timer address		Start day	Stop day	Start time	Stop time	Output time (mm:ss)	Application
@0	NDP	SU MO TU WE TH FR SA	SU MO TU WE TH FR SA None	:	:	:	
@1	NDP	SU MO TU WE TH FR SA	SU MO TU WE TH FR SA None	:	:	:	
@2	NDP	SU MO TU WE TH FR SA	SU MO TU WE TH FR SA None	:	:	:	
@3	NDP	SU MO TU WE TH FR SA	SU MO TU WE TH FR SA None	:	:	:	
@4	NDP	SU MO TU WE TH FR SA	SU MO TU WE TH FR SA None	:	:	:	
@5	NDP	SU MO TU WE TH FR SA	SU MO TU WE TH FR SA None	:	:	:	
@6	NDP	SU MO TU WE TH FR SA	SU MO TU WE TH FR SA None	:	:	:	
@7	NDP	SU MO TU WE TH FR SA	SU MO TU WE TH FR SA None	:	:	:	
@8	NDP	SU MO TU WE TH FR SA	SU MO TU WE TH FR SA None	:	:	:	
@9	NDP	SU MO TU WE TH FR SA	SU MO TU WE TH FR SA None	:	:	:	
@a	NDP	SU MO TU WE TH FR SA	SU MO TU WE TH FR SA None	:	:	:	
@b	NDP	SU MO TU WE TH FR SA	SU MO TU WE TH FR SA None	:	:	:	
@c	NDP	SU MO TU WE TH FR SA	SU MO TU WE TH FR SA None	:	:	:	
@d	NDP	SU MO TU WE TH FR SA	SU MO TU WE TH FR SA None	:	:	:	
@e	NDP	SU MO TU WE TH FR SA	SU MO TU WE TH FR SA None	:	:	:	
@f	NDP	SU MO TU WE TH FR SA	SU MO TU WE TH FR SA None	:	:	:	

**Note** N: Normal operation; D: Operation between days; P: Pulse operation

## Calendar Timer Settings

Calendar timer address	Start date	Stop date	Application
*0			
*1			
*2			
*3			
*4			
*5			
*6			
*7			
*8			
*9			
*a			
*b			
*c			
*d			
*e			
*f			

## Analog Comparator Settings

Analog comparator address	Comparison data 1		Operator	Comparison data 2	
	Inputs	Input device and specifications		Input/ No. of points	Input device and specifications
A0	I4 (la) I5 (lb)		≤ ≥	15 (lb) Constant ( . V)	
A1	I4 (la) I5 (lb)		≤ ≥	15 (lb) Constant ( . V)	
A2	I4 (la) I5 (lb)		≤ ≥	15 (lb) Constant ( . V)	
A3	I4 (la) I5 (lb)		≤ ≥	15 (lb) Constant ( . V)	

## Comparator Settings

Comparator address	Comparison data 1		Operator	Comparison data 2		
	Type	Content		Type	Content	Constant
P0	T□ #□ C□		≤ ≥	T□ #□ C□		
P1	T□ #□ C□		≤ ≥	T□ #□ C□		
P2	T□ #□ C□		≤ ≥	T□ #□ C□		
P3	T□ #□ C□		≤ ≥	T□ #□ C□		
P4	T□ #□ C□		≤ ≥	T□ #□ C□		
P5	T□ #□ C□		≤ ≥	T□ #□ C□		
P6	T□ #□ C□		≤ ≥	T□ #□ C□		
P7	T□ #□ C□		≤ ≥	T□ #□ C□		
P8	T□ #□ C□		≤ ≥	T□ #□ C□		
P9	T□ #□ C□		≤ ≥	T□ #□ C□		
Pa	T□ #□ C□		≤ ≥	T□ #□ C□		
Pb	T□ #□ C□		≤ ≥	T□ #□ C□		
Pc	T□ #□ C□		≤ ≥	T□ #□ C□		
Pd	T□ #□ C□		≤ ≥	T□ #□ C□		
Pe	T□ #□ C□		≤ ≥	T□ #□ C□		
Pf	T□ #□ C□		≤ ≥	T□ #□ C□		

## 8-Digit Comparator Settings

Comparator address	Operator	Constant	Application
G0	≤ ≥		
G1	≤ ≥		
G2	≤ ≥		
G3	≤ ≥		

# Display Function Settings

Display bit address	Backlight/Display function display screen switching	Display start position	Display message	Application
D0	L0 L1 L2 L3	X: Y:		
D1	L0 L1 L2 L3	X: Y:		
D2	L0 L1 L2 L3	X: Y:		
D3	L0 L1 L2 L3	X: Y:		
D4	L0 L1 L2 L3	X: Y:		
D5	L0 L1 L2 L3	X: Y:		
D6	L0 L1 L2 L3	X: Y:		
D7	L0 L1 L2 L3	X: Y:		
D8	L0 L1 L2 L3	X: Y:		
D9	L0 L1 L2 L3	X: Y:		
Da	L0 L1 L2 L3	X: Y:		
Db	L0 L1 L2 L3	X: Y:		
Dc	L0 L1 L2 L3	X: Y:		
Dd	L0 L1 L2 L3	X: Y:		
De	L0 L1 L2 L3	X: Y:		
Df	L0 L1 L2 L3	X: Y:		

	Backlight	Display function display screen switching
L0	No	No
L1	Yes	No
L2	No	Yes
L3	Yes	Yes

CHR	Characters (12 digits max.)
DAT	Month/day (5 digits: □□/□□)
DAT1	Day/month (5 digits: □□/□□)
CLK	Hour:minutes (5 digits: □□:□□)
I4/I5	Analog conversion (4 digits: □□.□)
la/b	
T0 to Tf	Timer present value (5 digits: □□.□□)
#0 to #7	Holding timer present value (5 digits: □□.□□)
C0 to Cf	Counter present value (4 digits: □□□□)
F0	8-Digit counter present value (8 digits: □□□□□□□□)

---

## Index

---

### A

- additional functions for bit outputs 29, 66
- allocations
  - allocation tables 157
  - I/O allocations 32, 157, 158
- alternate operation 4, 30, 65
- analog inputs 87
- application
  - examples 143–155
- available models 10

### B

- backlight
  - changing automatic cutout time 106
- Battery Unit 12
  - mounting 110
- blank lines
  - deleting 73
- button switches 17
  - using 99

### C

- calendar timers 86
- characteristics 122
- CLOCK 58
- comparators
  - addresses 64
  - analog 87
  - comparing present values 91, 94
- conduit installation 39
- connection lines 67
  - deleting 72
- counters
  - addresses 30, 64, 66
  - comparing values 91, 94
  - using 78
- CPU Units
  - available models 10

- specifications 123, 125

### D

- date
  - setting 58
- Daylight Saving Time (DST)
  - setting 107
- dimensions 127
- DIN track 33
  - mounting 37
- display bits
  - addresses 31, 66
  - displaying messages 96
- display language 57
- display screen 16
- duct installation 38

### E

- error messages
  - deleting 118
  - meaning 116
- Expansion I/O Units 19
  - available models 13
  - connecting 36
  - specifications 124, 125

### F

- false inputs 48
- features 8
- flashing pulse timer 75

### H

- holding timers 74

### I

- I/O bits

- allocation 32
- inductive loads 50, 53
- input devices
  - connecting 48
- inputs
  - analog 87
  - changing 71
  - deleting 72
  - input bits 29
  - input filter 104
  - stabilizing input operations 104
  - wiring input lines 40
  - writing 63
- inrush current
  - suppressing 54
- installation 36
- internal holding bits 29

## L

- Ladder Program Edit Screen settings
  - analog inputs 89
  - calendar timers 86
  - comparing present values 91, 94
  - counters 78
  - display bits 96
  - timers and holding timers 76
  - weekly timers 82
- ladder programs
  - See* programs
- language
  - selecting display language 57
- leakage current 48
- limit switches
  - preventing false inputs 48
- lines
  - inserting 72

## M

- memory
  - memory areas 29, 64, 65
- Memory Cassettes 9
  - mounting 111, 113
  - transferring programs 112

- MONITOR 70
- mounting 36
  - Battery Units 110

## O

- OFF delay timer 74
- ON delay timer 74
- one-shot pulse timer 75
- operating mode 70
  - RUN mode 20, 22
  - STOP mode 20, 22
- operation
  - confirming 69
  - preparation 33
- operation buttons 15, 17
- optional products 14
- outputs
  - changing additional bit output functions 71
  - deleting 72
  - output bits 29
  - wiring output circuits 51
  - writing 65

## P

- PARAMETER 22
- Parameter Monitor Screen Display
  - analog comparators 90
  - calendar timers 87
  - comparing present values 93, 95
  - counters 80
  - timers and holding timers 77
  - weekly timers 85
- Parameter Settings Screen settings
  - analog comparators 89
  - calendar timers 86
  - comparing present values 92, 94
  - counters 79
  - display bits 97
  - timers and holding timers 76
  - weekly timers 83
- part names 15
- password
  - deleting 103

- setting 103
- photoelectric switches
  - preventing false inputs 48
- power cables 38
- power supply
  - wiring 40
- Programming Device
  - available models 13
- programs
  - clearing 60
  - correcting 71
  - creating 60
  - examples 143
  - executing 129
  - execution time 130
  - protecting 102
  - writing 61
- proximity switches
  - preventing false inputs 48

## R

- reset input 76, 78
- reset operation 30, 65

## S

- set operation 30, 65
- settings
  - setting sheets 157
- specifications
  - general 119, 120

- input 123
- output 125
- Support Software 4
  - connecting 114
- switching capacity 125, 126
- system configuration 8
- system information
  - reading 108

## T

- time
  - setting 58
- timers 74
  - addresses 30, 64, 66
  - calendar timers 86
  - comparing values 91, 94
  - flashing pulse timer 75
  - OFF delay timer 74
  - ON delay timer 74
  - one-shot pulse timer 75
  - twin timer 75
  - weekly timers 81
- trigger input 74
- troubleshooting 116

## W

- weekly timers 81
- wiring 38
  - I/O 60
- work bits 29





## Revision History

A manual revision code appears as a suffix to the catalog number on the front cover of the manual.

Cat. No. Z211-E1-03



The following table outlines the changes made to the manual during each revision. Page numbers refer to the previous version.

Revision code	Date	Revised content
01	February 2006	Original production
02	September 2006	<p><b>Page xv:</b> Caution at bottom of page altered.</p> <p><b>Page xvii:</b> Description on “stranded wires” removed from item 4 under <i>Installation and Wiring</i>.</p> <p><b>Page xxi:</b> Item 4 removed.</p> <p><b>Page 36:</b> Step 1 replaced at bottom of page.</p> <p><b>Page 36:</b> Figure at bottom of page replaced.</p> <p><b>Page 40:</b> First paragraph removed and information on “twisted wires” removed. Caution on tightening torque altered.</p> <p><b>Pages 44 and 45:</b> Graphics at bottom of page altered.</p> <p><b>Page 48:</b> Graphics in 2nd, 4th, and 5th rows of table altered.</p> <p><b>Page 52:</b> First two paragraphs rewritten.</p> <p><b>Page 102:</b> Information added to precaution.</p> <p><b>Page 119:</b> Power consumption for “ZEN-10C3AR-A-V2” changed, inrush currents changed, and terminal block specification changed.</p> <p><b>Page 121:</b> “Pending approval” removed.</p> <p><b>Page 126:</b> Text in circuit drawing changed.</p> <p><b>Page 136:</b> Inrush current rows added to table.</p> <p><b>Page 140:</b> “DC power supply voltage” row moved to under “DC input circuits” and changed to “input voltage.”</p>
02A	May 2007	<p><b>Page 23:</b> Line for bottom arrow corrected.</p> <p><b>Page 42:</b> Top heading corrected.</p> <p><b>Page 107:</b> Description for NZ Type changed from “last Sunday” to “third Sunday.”</p> <p><b>Page 120:</b> Specification for vibration resistance changed from “double amplitude” to “single amplitude.”</p>
03	December 2008	<p><b>Page 13:</b> Added Vista for operating system of compatible computers.</p> <p><b>Page 107:</b> Changed times according to changes in summer time laws.</p>





**OMRON Corporation**

Industrial Automation Company

Control Devices Division H.Q.

Analog Controller Division

Shiokoji Horikawa, Shimogyo-ku,

Kyoto, 600-8530 Japan

Tel: (81) 75-344-7080/Fax: (81) 75-344-7149

2-2-1 Nishikusatsu, Kusatsu-shi,

Shiga, 525-0035 Japan

Tel: (81) 77-565-5216/Fax: (81) 77-565-5568

**Regional Headquarters****OMRON EUROPE B.V.**

Wegalaan 67-69-2132 JD Hoofddorp

The Netherlands

Tel: (31)2356-81-300/Fax: (31)2356-81-388

OMRON Industrial Automation Global: [www.ia.omron.com](http://www.ia.omron.com)**OMRON ELECTRONICS LLC**

One Commerce Drive Schaumburg,

IL 60173-5302 U.S.A.

Tel: (1) 847-843-7900/Fax: (1) 847-843-7787

**OMRON ASIA PACIFIC PTE. LTD.**

No. 438A Alexandra Road # 05-05/08 (Lobby 2),

Alexandra Technopark, Singapore 119967

Tel: (65) 6835-3011/Fax: (65) 6835-2711

**OMRON (CHINA) CO., LTD.**

Room 2211, Bank of China Tower,

200 Yin Cheng Zhong Road,

PuDong New Area, Shanghai, 200120, China

Tel: (86) 21-5037-2222/Fax: (86) 21-5037-2200

**Authorized Distributor:**

© OMRON Corporation 2006 All Rights Reserved.

In the interest of product improvement,  
specifications are subject to change without notice.

Cat. No. Z211-E1-03

Printed in Japan  
1208-0.3M (1205) (C)